

# *Digital HD Videocassette Recorder*

---

Operating Instructions

**HDV**  
HDV 1080i **DVCAM**<sup>™</sup> **DV** Digital Video Cassette **Mini DV** Digital Video Cassette

**HVR-M15U/M15N/M15E/M15P**

## WARNING

To reduce fire or shock hazard, do not expose the unit to rain or moisture.

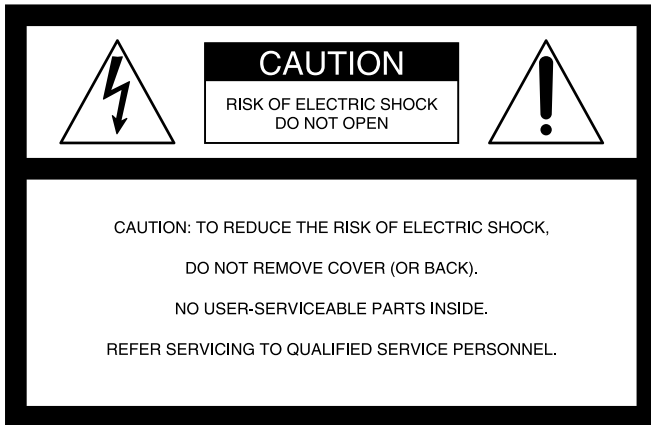

This symbol is intended to alert the user to the presence of uninsulated “dangerous voltage” within the product’s enclosure that may be of sufficient magnitude to constitute a risk of electric shock to persons.



This symbol is intended to alert the user to the presence of important operating and maintenance (servicing) instructions in the literature accompanying the appliance.

### Owner’s record

The model number and the serial number are located at the name plate on the left of the unit. Record the serial number in the space provided below. Refer to these numbers whenever you call upon your Sony dealer regarding this product.

Model No. HVR-                      Serial No. \_\_\_\_\_  
Model No. AC-L15A                Serial No. \_\_\_\_\_

### For customers in the U.S.A.

HVR-M15U only

If you have any questions about this product, you may call: *Sony’s Business Information Center (BIC) at 1-800-686-SONY (7669)*

or Write to: *Sony Customer Information Services Center  
6900-29 Daniels Parkway, PMB 330 Fort  
Myers, Florida 33912*

### Declaration of Conformity

Trade Name:                      SONY  
Model:                              HVR-M15U  
Responsible Party:              Sony Electronics Inc.  
Address:                            16530 Via Esprillo, San Diego, CA  
    92127 U.S.A.  
Telephone Number:              858-942-2230

This device complies with Part 15 of the FCC Rules. Operation is subject to the following two conditions:  
(1) This device may not cause harmful interference, and  
(2) this device must accept any interference received, including interference that may cause undesired operation.

## CAUTION

You are cautioned that any changes or modifications not expressly approved in this manual could void your authority to operate this equipment.

### NOTE:

This equipment has been tested and found to comply with the limits for Class B digital device, pursuant to Part 15 of the FCC Rules.

These limits are designed to provide reasonable protection against harmful interference in a residential installation. This equipment generates, uses, and can radiate radio frequency energy and, if not installed and used in accordance with the instructions, may cause harmful interference to radio communications.

However, there is no guarantee that interference will not occur in a particular installation. If this equipment does cause harmful interference to radio or television reception, which can be determined by turning the equipment off and on, the user is encouraged to try to correct the interference by one or more of the following measures:

- Reorient or relocate the receiving antenna.
- Increase the separation between the equipment and receiver.
- Connect the equipment into an outlet on a circuit different from that to which the receiver is connected.
- Consult the dealer or an experienced radio/TV technician for help.

---

## NOTICE FOR CUSTOMERS IN THE UNITED KINGDOM

### HVR-M15E only

A moulded plug complying with BS1363 is fitted to this equipment for your safety and convenience.

Should the fuse in the plug supplied need to be replaced, a fuse of the same rating as the supplied one and approved by ASTA or BSI to BS1362 (i.e., marked with ⚡ or ⚡ mark) must be used.

If the plug supplied with this equipment has a detachable fuse cover, be sure to attach the fuse cover after you change the fuse. Never use the plug without the fuse cover. If you should lose the fuse cover, please contact your nearest Sony service station.

### Disposal of Waste Electrical and Electronic Equipment for business use (Applicable in the European Union and other European countries with separate collection systems)

This symbol on the product or on its packaging indicates that this product shall not be treated as household waste. Instead it shall be handed over to the applicable take-back scheme for the recycling of electrical and electronic equipment. By ensuring this product is disposed of correctly, you will help prevent potential negative consequences for the environment and human health, which could otherwise be caused by inappropriate waste handling of this product. The recycling of materials will help to conserve natural resources. For more detailed information about recycling of this product, please contact your local Sony office or visit Sony Europe's web site for business customers: <http://www.sonybiz.net/environment>



### For the customers in Europe

#### HVR-M15E only

This product with the CE marking complies with both the EMC Directive (89/336/EEC) and the Low Voltage Directive (73/23/EEC) issued by the Commission of the European Community.

Compliance with these directives implies conformity to the following European standards:

- EN60065 :Product Safety (Supplied AC Adapter only)
- EN55103-1 :Electromagnetic Interference (Emission)
- EN55103-2 :Electromagnetic Susceptibility (Immunity)

This product is intended for use in the following Electromagnetic Environment(s):

E1 (residential), E2 (commercial and light industrial), E3 (urban outdoors) and E4 (controlled EMC environment ex. TV studio).

#### ATTENTION

The electromagnetic fields at the specific frequencies may influence the picture and sound of this unit.

### For the customers in the Nederland Voor de klanten in Nederland

Dit apparaat bevat een vast ingebouwde batterij die niet vervangen hoeft te worden tijdens de levensduur van het apparaat.

Raadpleeg uw leverancier indien de batterij toch vervangen moet worden.

De batterij mag alleen vervangen worden door vakbekwaam servicepersoneel.

Gooi de batterij niet weg maar lever deze in als klein chemisch afval (KCA).

Lever het apparaat aan het einde van de levensduur in voor recycling, de batterij zal dan op correcte wijze verwerkt worden.



---

### Caution

Television programs, films, video tapes and other materials may be copyrighted. Unauthorized recording of such material may be contrary to the provisions of the copyright laws. Also, use of this recorder with cable television transmission may require authorization from the cable television transmission and/or program owner.

# Table of Contents

## Chapter1

### Overview

<b>Features .....</b>	<b>6</b>
<b>Location and Function of Parts .....</b>	<b>8</b>
Front Panel .....	8
Rear Panel .....	13
Supplied Remote Commander .....	16
<b>Displaying Various Data.....</b>	<b>18</b>

## Chapter2

### Playback and Recording

<b>Notes on Power Supply and Video Cassettes .....</b>	<b>20</b>
Preparing the Power Supply .....	21
Inserting/Ejecting Cassettes .....	21
Notes on Playback/Recording .....	22
Installing the Unit Vertically .....	23
<b>Playback.....</b>	<b>24</b>
Connections for Playback.....	24
Settings for Playback.....	27
Playback Procedures .....	27
Playback Functions .....	28
<b>Using the Unit as a Videocassette Recorder .....</b>	<b>32</b>
Connections for Recording.....	32
Settings for Recording.....	34
Recording Procedures .....	36
Recording Functions .....	36

## Chapter3

### Dubbing/Editing

<b>Dubbing to another equipment .....</b>	<b>37</b>
Connections for Dubbing .....	37
Dubbing procedures .....	40
<b>Editing (Connecting with a Computer).....</b>	<b>41</b>
Connecting the Unit to a Computer.....	41
Preparations .....	42

---

## **Chapter4**

### **Adjusting and Setting Through Menus**

<b>Operating the Menus .....</b>	<b>44</b>
Menu Organization .....	45
Menu Contents .....	46

---

## **Chapter5**

### **Maintenance**

<b>Troubleshooting .....</b>	<b>56</b>
<b>Warning indicators and messages .....</b>	<b>62</b>
<b>Notes on Use .....</b>	<b>64</b>
Notes on the Videocassette Recorder .....	64
Cleaning of the Video Heads .....	64
Notes on the Video Cassettes .....	65
About Moisture Condensation .....	66
Digital Hours Meter .....	66
About the Built-in Rechargeable Battery .....	67
Using your Videocassette Recorder abroad.....	67
Notes on the License .....	67

---

## **Appendix**

<b>Compatibility of HDV, DVCAM, and DV Formats .....</b>	<b>68</b>
<b>About i.LINK .....</b>	<b>73</b>
<b>Specifications .....</b>	<b>74</b>
<b>Index .....</b>	<b>77</b>
<b>Submenu Index .....</b>	<b>78</b>

# Overview

## Features

The HVR-M15U/M15N/M15E/M15P is a digital HD videocassette recorder supporting HDV format and DVCAM/DV format. The unit produces stable, superior picture quality by digital processing and separating image signals into color difference signals and a luminance signal (component video). The unit provides i.LINK (  HDV/DV) jack, COMPONENT OUT jacks, S VIDEO IN/OUT jacks, composite IN/OUT jacks, and AUDIO IN/OUT jacks. These jacks allow you to connect other equipment like non-linear editors. The main features of the unit are described below.

---

### HDV format

The unit can perform HDV (High-Definition Digital Video) recording and playback on a DVCAM format video cassette or a DV format video cassette. The compression system of HDV format is the MPEG2 system adopted in the high-definition broadcasting and the Blu-ray Disk System. The unit adopts the 1080 scanning lines (interlace (HDV1080/60i and HDV1080/50i)/1440 × 1080 pixels) format of the HDV specifications. The recording bit rate is approximately 25 Mbps. The unit is equipped with an i.LINK digital interface and can be digitally connected with HDV-compatible televisions or computers.

---

### DVCAM/DV format

DVCAM is based on the consumer DV format, which uses the 4:1:1 component digital format (60i) or the 4:2:0 format (50i), and provides a 1/4-inch digital recording format for professional use. The unit provides both DVCAM format recording/playback and DV format in SP mode recording/playback.

*For details, see “Compatibility of HDV, DVCAM, and DV Formats” on page 68.*

---

### Compatible with both 1080/60i (NTSC) and 1080/50i (PAL) systems

The unit is compatible with 60i and 50i systems. You can switch these input signals using the menu setting (*page 55*). This compatibility allows you to record (download) or play back (upload) both 50i and 60i signals with your VCR, computer, or other equipment. However, the unit cannot convert the color system of the signals.

The unit set in 60i system has a field frequency of 59.94 Hz.

---

## High definition down convert function

When you want to playback a tape recorded in HDV format, you can down convert any images to output them. This function allows you to preview recorded-images on a monitor which is not compatible with High-Definition (HD) format. Also, you can select an aspect ratio from SQUEEZE, LETTER BOX (except , HDV/DV jack output), or EDGE CROP.

---

## Multiple input/output interfaces

 HDV/DV jack, COMPONENT OUT jacks, S VIDEO jacks and VIDEO jacks and AUDIO jacks are equipped on the unit and enable the connection with various devices.

---

## JOG AUDIO function

If you use the optional remote control unit DSRM-10 (not supplied), audio can be monitored at various playback speeds when in jog/shuttle mode. (Jog audio cannot be output when the tape is recorded in HDV format.)

---

## Screen Language Setting

You can select the language.  
The default language setting is English.  
*See page 53 to change the screen language.*

---

## Compact size allowing vertical installation

The compact size of the unit allows installation in a vertical position and saves space. During non-linear editing, you can install the unit in a vertical position next to the computer and save working space.

---

## Easy maintenance functions

- **Self-diagnostics/alarm functions:** The system automatically detects an invalid operation, bad connection or a malfunction, and outputs a description, a cause and a recovery method with COMPONENT OUT jacks, S VIDEO jack, and VIDEO jack.
- **Digital hours meter:** A digital hours meter counts four types of time data—operating time, drum rotation time, tape running time, and tape threading/unthreading. The digital hours data are indicated on the menu.

.....  
, , and  are trademarks of Sony Corporation.

**HDV** is a trademark of Sony Corporation and Victor Company of Japan Ltd.

All other product names mentioned here may be the trademarks or registered trademarks of their respective companies. “™” and “®” are not mentioned in each case in this manual.

# Location and Function of Parts

## Front Panel

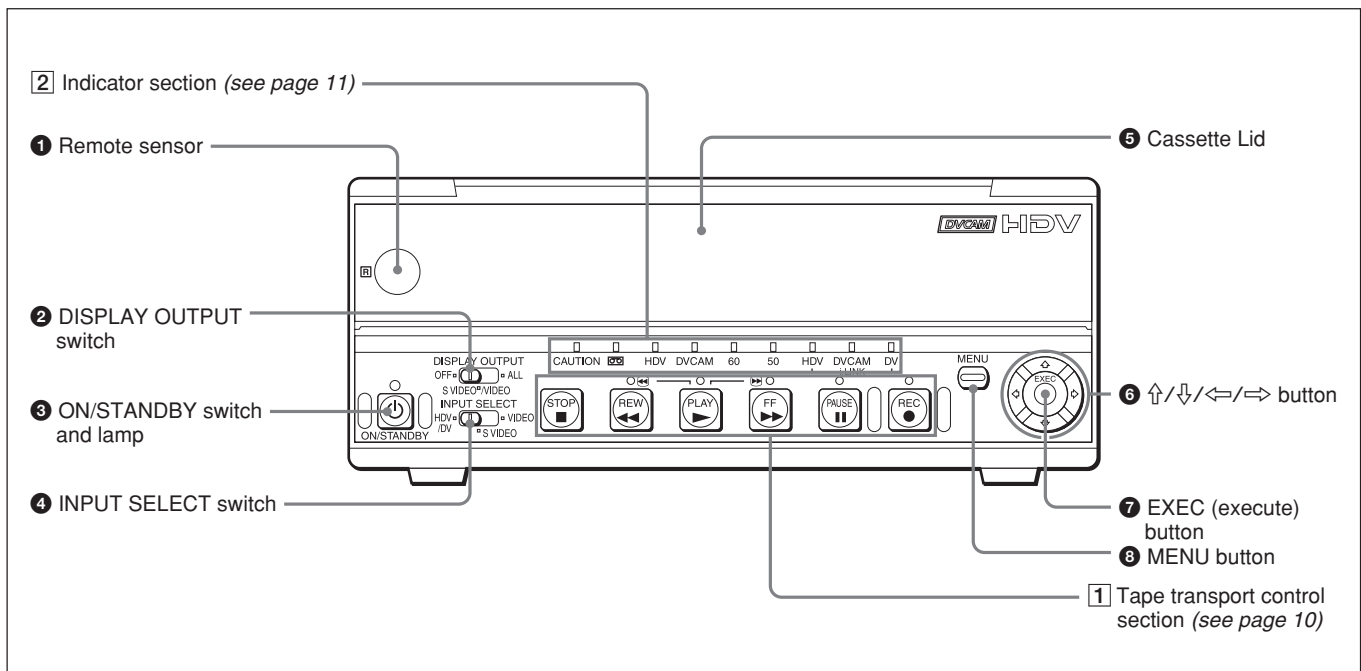

### 1 Remote sensor

### 2 DISPLAY OUTPUT switch

Selects the destination for the text data to be superimposed via output jacks.

**OFF** : Does not superimpose text data to output.

**S VIDEO/VIDEO** : Superimposes text data to S VIDEO OUT jack and VIDEO OUT jack.

**ALL** : Superimposes text data to COMPONENT OUT jacks, S VIDEO OUT jack, and VIDEO OUT jack.

### 3 ON/STANDBY switch and lamp

Press this switch to turn the unit on, and the ON/STANDBY lamp lights up in green. When you press this switch again, the unit goes into STANDBY mode and the lamp lights up in red.

### 4 INPUT SELECT switch

Switches the signal input jack from **i** HDV/DV jack, S VIDEO jack, and VIDEO jack.

**HDV/DV** : Inputs a signal from **i** HDV/DV jack.

**S VIDEO** : Inputs a signal from S VIDEO jack.

**VIDEO** : Inputs a signal from VIDEO jack.

### Notes

- Do not change the setting of this switch while recording in progress, or it causes noise added to images and sounds. Also, a part of the tape where the change of setting applied will not be recorded properly. Also, the time code may operate discontinuously.
- If you change the setting of this switch while recording in progress, the output signal from **i** HDV/DV jack may be interrupted. Also, the unit may detect signals such as a copyright information signal incorrectly.
- When a signal is input from **i** HDV/DV jack, the settings of the menu listed below are unavailable.
  - 60i/50i SEL
  - AUDIO MODE
  - AUDIO LOCK
  - AUDIO AGC
  - AUDIO REC LV

### 5 Cassette Lid

Open this lid to insert or eject a cassette.

For details of usable cassettes, see “Notes on Power Supply and Video Cassettes” on page 20.

For details of inserting or ejecting a cassette, see “Inserting/Ejecting Cassettes” on page 21.



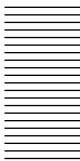

---

**6** ↑/↓/⇐/⇒ **button**

Use these buttons in menu settings and other settings.

**7** EXEC (execute) **button**

Use this button in menu settings.

**8** MENU **button**

Press this button to display the menu on screen.

# Location and Function of Parts

## 1 Tape transport control section

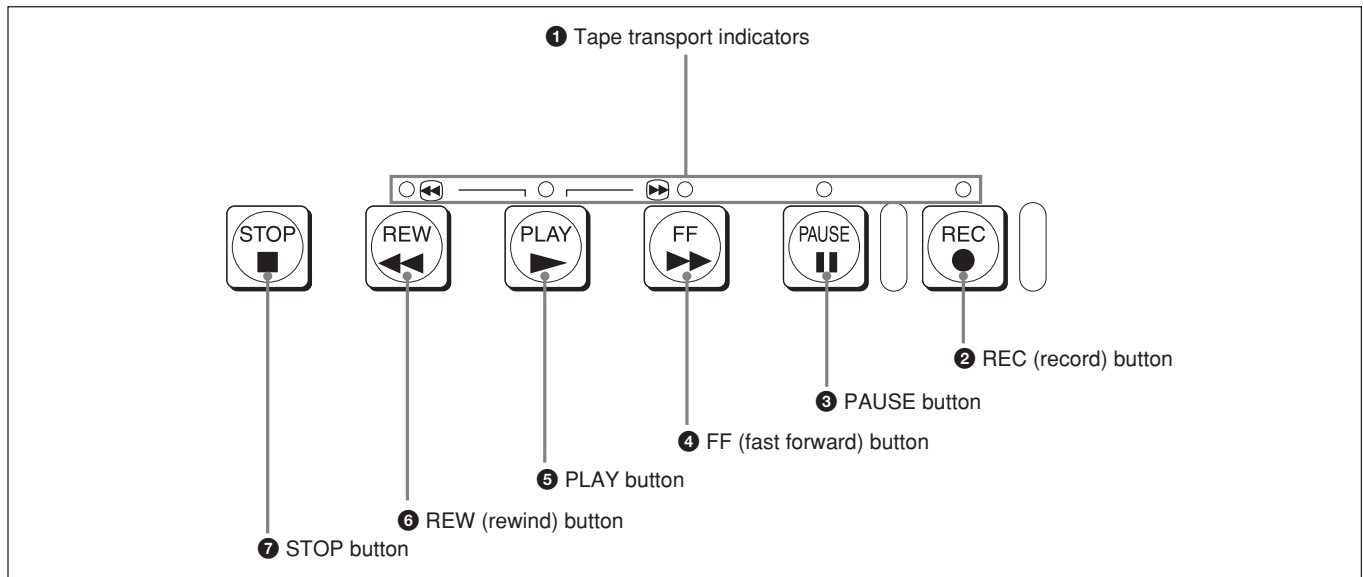

### 1 Tape transport indicators

### 2 REC (record) button

When you press and hold this button then press PLAY button, the each indicator lights and recording starts. If you press this button while the tape is stopped, you can check EE picture and audio signals for a moment. When HDV/DV is selected, if [HDV/DV IN TC] in [TC/UB SET] menu is set to [EXTERNAL], you can also check EE time code signals. Press STOP button to end the check.

For details, see “EE/PB SEL” in “IN/OUT REC” menu on page 48.

For details of the time code, see “TC/UB SET” on page 52.

### Notes

- The unit does not have an LP recording mode of the consumer DV format. Only recording in SP mode is available.
- To set the unit to recording pause mode with the remote control unit DSRM-10 (not supplied), press PAUSE button while holding down PLAY button to set the unit to the playback pause mode, then press REC button on the DSRM-10.
- When the recording mode is displayed in HDV, it may take a few seconds to start recording. During this time, REC indicator blinks.

### 3 PAUSE button

Press this button to set the unit to pause mode while recording or playing. Press this button again to resume the operation.

### 4 FF (fast forward) button

When you press this button, the indicator lights and the tape is fast forwarded. During fast forward, the picture does not appear on the monitor (you can see the picture as it is seen in EE mode<sup>1)</sup> during fast forward). To locate a scene while monitoring the picture, keep pressing this button during fast forward, playback or in playback pause mode (picture search).

### Notes

- If you set [EE/PB SEL] in [IN/OUT REC] menu to [PB], EE picture and EE audio signals are not output.
- If you set [FF/REW SPEED] in [VTR SET] menu to [SHUTTLEMAX], the picture is played back during fast forward.

For details on running speed with [SHUTTLEMAX], see “FF/REW SPEED” in “VTR SET” menu on page 51.

1) “EE” stands for “Electric to Electric.” In EE mode, the video and audio signals input to the VCR’s recording circuitry do not pass through any magnetic conversion circuits but output via electric circuits only. This mode is used to check the input signals and adjust input levels. The pictures output in EE mode are referred to as EE pictures.

## 5 PLAY button

When you press this button, the indicator lights and playback begins.

If you press this button while holding down REW button during stop, the tape is rewound to its beginning and starts playing automatically (during rewind, REW indicator lights and PLAY indicator blinks).

### Notes

- When the unit is playing back a part of the tape where the recording format has been changed within HDV format, DVCAM format, or DV format, or between 60i format and 50i format, the picture and sound may be distorted.
- The unit does not have an LP recording mode of the consumer DV format.

## 6 REW (rewind) button

When you press this button, the indicator lights and the tape starts rewinding.

During rewind, the image on the monitor is not displayed (you can see the picture as it is seen in EE mode during rewind). To locate a scene while monitoring the picture, hold this button down during rewind, playback or in the playback pause mode. If you press PLAY button while holding down this button during stop, the tape is rewound to its beginning and starts playing automatically (during rewind, REW indicator lights and PLAY indicator blinks).

### Notes

- If you set [EE/PB SEL] in [IN/OUT REC] menu to [PB], EE picture and EE audio signals will not be output.
- If you set [FF/REW SPEED] in [VTR SET] menu to [SHUTTLEMAX], the picture is played back during rewind.

For details on running speed with [SHUTTLEMAX], see “FF/REW SPEED” in “VTR SET” menu on page 51.

## 7 STOP button

Press this button to stop the tape transport operation completely.

## 2 Indicator section

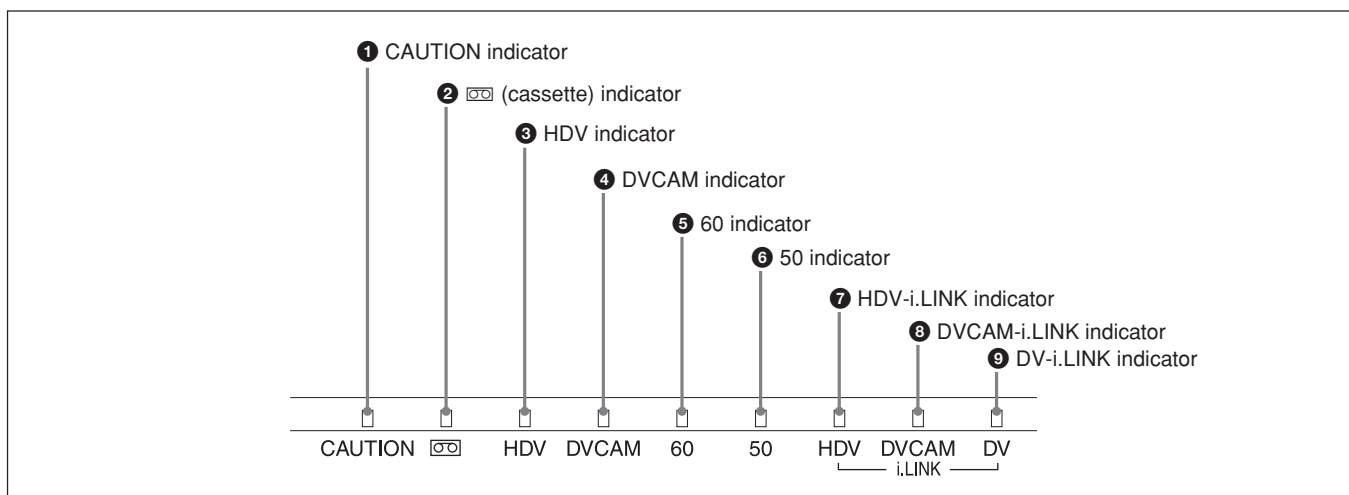

### 1 CAUTION indicator

Blinks when an error occurs.

For details on cautions, see “Self-diagnosis display/Warning Indicators” on page 62.

### 2 (cassette) indicator

Lights when a digital video cassette is loaded. This indicator lights during standby, when the cassette is inserted to the unit. While the cassette is being ejected, the indicator blinks.

For details of inserting or ejecting a cassette, see “Inserting/Ejecting Cassettes” on page 21.

(Continued)

## Location and Function of Parts

### ③ HDV indicator

Lights when the unit is in the following operating status.

- When a tape recorded in HDV format is being played back.
- When HDV signals are input through the i.LINK interface.
- When [HDV/DV SEL] in [IN/OUT REC] menu is set to [HDV].\*

\* Even when [HDV/DV SEL] is set to [AUTO] with no signal input, while the last signal input was HDV format or the last tape played was in HDV format, this indicator lights.

### ④ DVCAM indicator

Lights when the unit is in the following operating status.

- When a tape recorded in DVCAM format is being played back.
- When [HDV/DV SEL] in [IN/OUT REC] menu is set to [DV] and [REC MODE] in [IN/OUT REC] menu is set to [DVCAM] (during recording or in EE mode).\*

\* Neither HDV indicator nor DVCAM indicator lights during recording in DV (SP) format or a playback of a tape recorded in DV (SP) format.

### ⑤ 60 indicator

Lights when the unit is in the following operating status.

- During recording or in EE mode when [60i/50i SEL] in [OTHERS] menu is set to [60i].
- During HDV1080/60i or NTSC signals are input from  HDV/DV jack.
- A tape that has HDV1080/60i or NTSC signals are being played back.

### ⑥ 50 indicator

Lights when the unit is in the following operating status.

- During recording or in EE mode when [60i/50i SEL] in [OTHERS] menu is set to [50i].
- During HDV1080/50i, or PAL signals are input from  HDV/DV jack.
- A tape that has HDV1080/50i or PAL signals are being played back.

### ⑦ HDV-i.LINK indicator

Lights when HDV signals are input/output through the i.LINK interface.

### ⑧ DVCAM-i.LINK indicator

Lights when DVCAM signals are input/output through the i.LINK interface.

### ⑨ DV-i.LINK indicator

Lights when DV signals are input/output through the i.LINK interface.

## Rear Panel

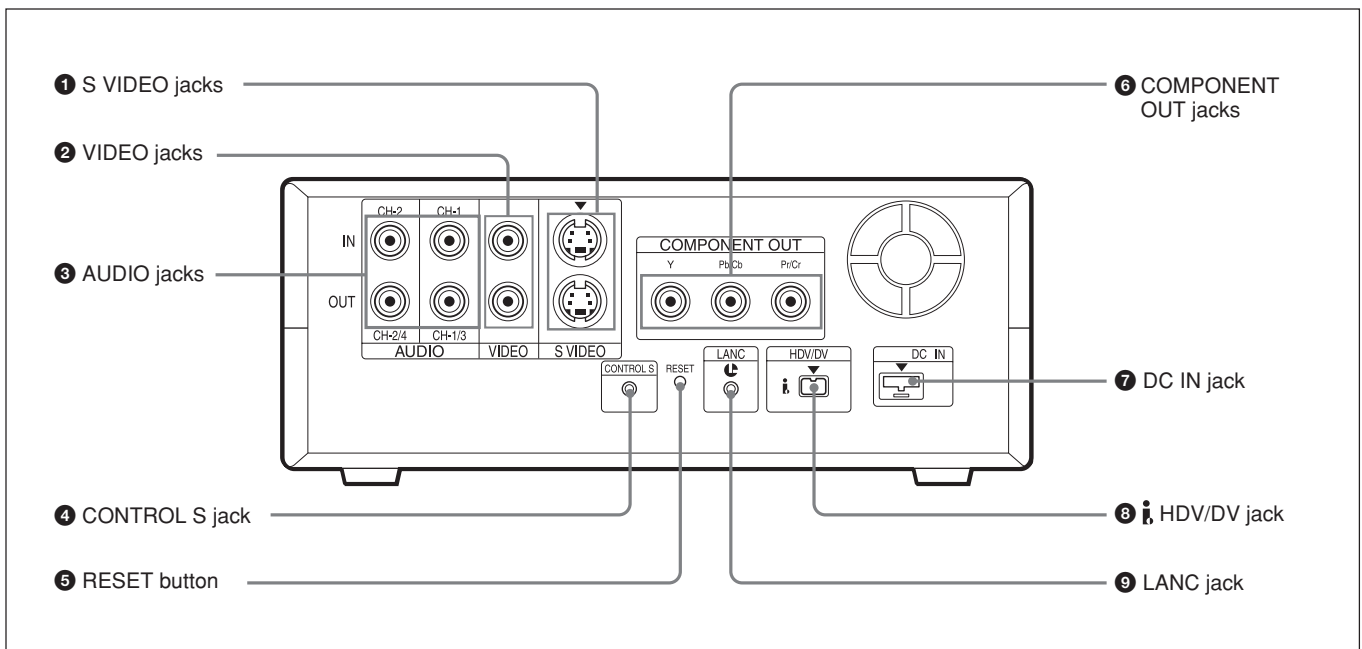

### 1 S VIDEO jacks

To connect a device equipped with an S VIDEO jack, use S VIDEO jacks on the unit.

If you use S VIDEO jacks, you can input/output high-quality video with less signals deterioration in quality than the one connected to the standard VIDEO jack.

When DISPLAY OUTPUT switch is set to S VIDEO/VIDEO or ALL, text data such as the time code, menus, and alarm messages are superimposed on an external monitor connected to S VIDEO jack (page 18).

### 2 VIDEO jacks

Use to input and output analog video signals.

Text data is superimposed on a monitor in the same way as S VIDEO jack connection (page 18).

### 3 AUDIO jacks

Use to input and output analog audio signals.

When [AUDIO MODE] in [AUDIO SET] menu is set to [FS32K], audio source will be recorded on channels 1 and 2.

#### Notes

- When the audio mode is FS32K (4 channel), if you select [MIX] of [AUDIO MIX] in [AUDIO SET] menu, the audio output level becomes 50% (-6 dB) of the original audio level on each channel.

- If you input a sound whose level exceeds the acceptable range, the sound recorded will be distorted.

*For details on the available volume levels, see the "Specifications" of the unit (page 74).*

### 4 CONTROL S jack

Connect to a remote control unit DSRM-10 (not supplied) for controlling the unit.

You can also use the DSRM-20 (no longer manufactured: not supplied).

#### Note

When you use a CONTROL S device, set [COMMANDER] in [OTHERS] menu to [CONTROL S].

### 5 RESET button

If you press this button with the tip of a ballpoint pen or similar tool, the following settings are initialized.

- [CLOCK SET] (page 54) and [60i/50i SEL] (page 55) in [OTHERS] menu.
- The setting on the unit except the menu settings.

(Continued)

## Location and Function of Parts

### 6 COMPONENT OUT jacks

Use to output component signals.

To connect a device equipped with the component video input connectors, use COMPONENT OUT jacks on the unit. If you use COMPONENT OUT jacks, you can output high-quality video with even less signal deterioration in quality compared with S VIDEO jack. You can set the output video format by using [COMPONENT] of [VIDEO OUT] in [IN/OUT REC] menu.

When DISPLAY OUTPUT switch is set to ALL, text data such as time code, menu, and alarm messages are superimposed on a monitor connected using COMPONENT OUT jacks (page 18).

#### Notes

- When you change the video format setting of [COMPONENT] of [VIDEO OUT] in [IN/OUT REC] menu, the images output from i.LINK HDV/DV jack, S VIDEO jack, and VIDEO jack may be distorted for a moment.
- The output level of COMPONENT OUT jacks is as follows:

Output at 480i NTSC

With [BETACAM] selected in [IN/OUT REC] menu

Y: 1.0 Vp-p  
(with 0.286 Vp-p sync negative,  
output impedance 75 Ω (ohms), unbalanced)  
Pb/Cb/B-Y, Pr/Cr/R-Y: 0.7 Vp-p  
(output impedance 75 Ω (ohms), unbalanced)  
(75% color bars with 7.5 IRE setup)

With [SMPTE] selected in [IN/OUT REC] menu

Y: 1.0 Vp-p  
(with 0.3 Vp-p sync negative,  
output impedance 75 Ω (ohms), unbalanced)  
Pb/Cb/B-Y, Pr/Cr/R-Y: 0.7 Vp-p  
(output impedance 75 Ω (ohms), unbalanced)  
(100% color bars with no setup)

Output with other settings

Y: 1.0 Vp-p  
(output impedance 75 Ω (ohms), unbalanced)  
Pb/Cb/B-Y, Pr/Cr/R-Y: 0.7 Vp-p  
(output impedance 75 Ω (ohms), unbalanced)  
(100% color bars with no setup)

480i/480p:

Y: with 0.3 Vp-p sync negative

1080i:

Y/Pb/Pr: with 0.6 Vp-p 3-level sync

- When you play back HDV-formatted tape with copyright protected signals or input i.LINK signals with copyright protection to i.LINK HDV/DV jack, pictures may be output in either 480i (NTSC) or 576i (PAL) format regardless of the setting of [COMPONENT] of [VIDEO OUT] in [IN/OUT REC] menu.
- When you play back a tape in DVCAM/DV, and while an EE picture in NTSC/PAL is displayed, the 480i resolution or the 576i resolution is output, regardless of the setting of [COMPONENT] of [VIDEO OUT] in [IN/OUT REC] menu.

### 7 DC IN jack

Connect to the AC outlet using the supplied AC adaptor.

### 8 i.LINK HDV/DV jack (4-pin)

Use this jack to input/output the digital signals that complies with the i.LINK standard. Use when a device connected to the unit has an i.LINK jack. If you connect the unit and another device using i.LINK HDV/DV jack, you can minimize deterioration of picture quality during recording, dubbing, or capturing still pictures, all by means of digital signal processing.

*For details, refer to the instruction manual of the external device.*

#### Notes

- When you connect with the i.LINK cable to a computer and the unit, check the direction of the jack. If you forcibly insert the jack, the terminal may be damaged or cause the unit to malfunction. Align ▲ mark of the i.LINK cable with ▼ mark on the unit and insert the i.LINK cable.
- This jack is only compatible with HDV1080i/DVCAM/DV signals.  
*For details, see "About i.LINK" on page 73.*
- If video signals have been input to i.LINK HDV/DV jack and you output these video signals to S VIDEO or VIDEO connectors, the sync and burst of the corresponding EE picture is not synchronized.
- If the unit is connected to a device equipped with an i.LINK jack, when you intend to disconnect or reconnect the i.LINK cable, turn off the device and pull out the plug of its power cord from the AC outlet beforehand. If you connect or disconnect i.LINK cable while the device is connected to the AC outlet, high-voltage current (8 to 40 V) is output from the i.LINK jack of the device to the unit, which may cause a malfunction.

- When connecting a device that has a 6-pin i.LINK jack to the unit, first, connect the plug of the cable to the 6-pin i.LINK jack.
- The video signal which is input from i HDV/DV jack will output directly to COMPONENT OUT jacks, S VIDEO jack, and VIDEO jack with the jitter of i.LINK signal. This jitter may be displayed on a monitor continuously. Be careful with this jitter when you connect the unit to other recording devices for recordings. This jitter will not affect on a recording with the unit.
- When you change the video format setting of [DOWN CONVERT] of [i.LINK SET] in [IN/OUT REC] menu, the video signal output from COMPONENT OUT jacks, S VIDEO OUT jack, or VIDEO OUT jack might be distorted for a moment.

### 9 LANC jack

Use this jack when controlling the tape transport operation of the unit using a device that has a LANC<sup>1)</sup> jack.

#### Notes

- LANC jack on the unit has only LANC-S functions. The unit has no LANC-M functions. A device that is set to LANC-S mode cannot be connected to the unit. Either this, the unit or the other device may not operate properly.
- When using the unit as a player, set LANC mode on the recorder to M. A device that does not have an M/S switching function cannot be used to control the unit.
- When the device for connecting to the unit has [LANC-M] function to switch between SHUTTLE A/B, select SHUTTLE A for HDV-formatted tape, and SHUTTLE B for the DVCAM/DV-formatted tape.
- LANC connection transmits command signals for playback, stop, pause playback, as well as the time code, tape counter, and data status of the unit.
- Jacks labeled CONTROL L have the same function as LANC jacks.
- There are some limitations when you edit an HDV-formatted tape.

*Refer to the "Notes" in "Preparations" on page 42.*

#### Notes on all Video output jacks

- The unit is only compatible with standard video signals. If you input the types of video signals shown below, recorded picture and sound may be distorted.
  - Signals from some home game machines
  - Blue background screen or gray background screen from a consumer VCR
  - Pictures played at a speed other than normal by a VCR that does not have the TBC (Time Base Corrector)
  - Video signals in which the sync signals are distorted
  - Signals from a defective cassette (tape or recording condition is bad) played by an analog VCR that does not have TBC
- To absorb the jitter of input video signals, the distortion of video signals are processed in the underscan portion. You may see this procedure on an underscan monitor, yet this is not a malfunction. Also, the picture recorded on the tape will not be affected.
- To output video signals to VIDEO, S VIDEO, or COMPONENT OUT jacks without text data, set DISPLAY OUTPUT switch to OFF.
- During recording or in EE mode, the subcarrier of the color signal to be output from the unit is not synchronized with the horizontal sync signal. The color of the picture or the horizontal sync signal may be distorted depending on the type of monitor connected to the unit.

1) LANC (Local Application Control bus system):  
Bidirectional interface used to control a consumer VCR

## Supplied Remote Commander

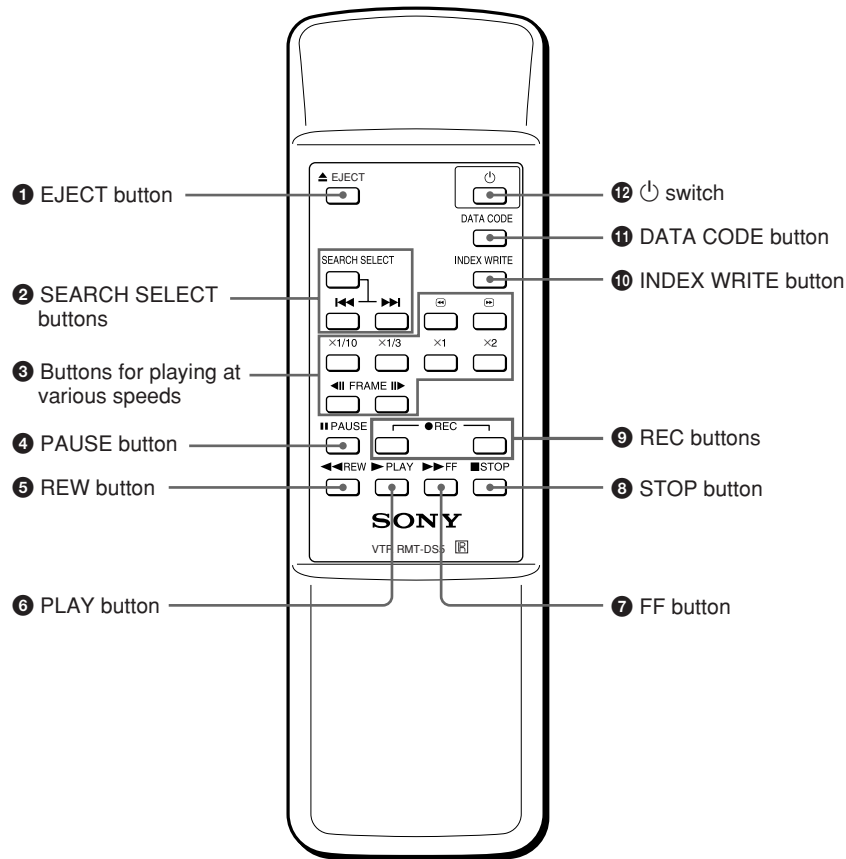

### 1 EJECT button

#### Note

The unit does not open and close Cassette Lid **5** (page 8) automatically. When you eject a tape by using EJECT button on Remote Commander, open Cassette Lid beforehand, then press EJECT button.

### 2 SEARCH SELECT buttons

Press these buttons to search for scenes using the search function.

For details on the search function, see “Searching using the search function” on page 30.

### 3 Buttons for playing at various speeds

You can play back a tape at normal speed or at a speed other than normal with these buttons.

For details, see “Playing at various speeds” on page 29.

### 4 PAUSE button

### 5 REW (rewind) button

### 6 PLAY button

### 7 FF (fast forward) button

### 8 STOP button

### 9 REC (record) buttons

When you press both these buttons at the same time, REC indicator and PLAY indicator on the front panel light and recording begins.

### 10 INDEX WRITE button

Press this button during recording to mark an index. For details on an index, see “Marking an index” on page 36.



**11 DATA CODE button**

Press this button to display the data codes (recording date/time, camera data).

For details on data codes, see “Displaying information (data codes) recorded on a tape” on page 28.

**12  (on/standby) switch****Notes**

- The command mode of the supplied Remote commander is set to VTR4.
- Set [COMMANDER] in [OTHERS] menu to [WIRELESS] to enable Remote Commander to control the unit.
- In addition to Remote Commander supplied with the unit, the unit accepts signals from any Sony Remote Commander whose command mode is set to VTR4. To disable the control from Remote Commander, set [COMMANDER] in [OTHERS] menu to [CONTROL S].

**Battery installation**

- 1 Push and slide the lid to open.

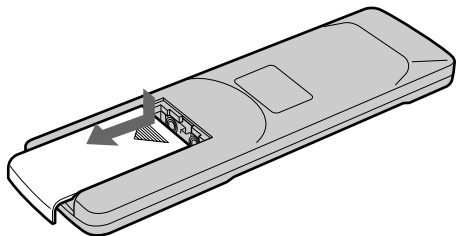

- 2 Install two size AA (R6) batteries (supplied) with the correct polarity.

Be sure to install the battery from the ⊖ side.

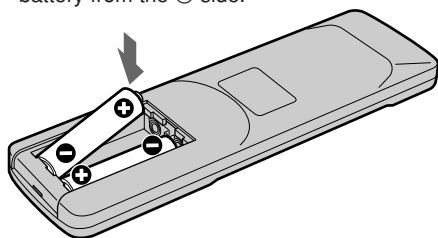

- 3 Put the lid back.

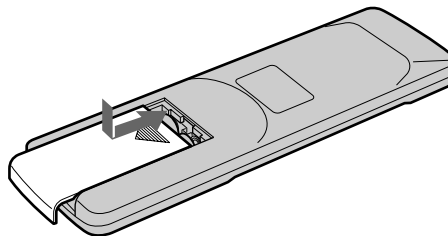
**Notes on batteries**

- Make sure that the battery orientation is correct when inserting batteries.
- Do not mix an old battery with a new one, or mix different types of batteries.
- If you do not intend to use Remote Commander for a long time, remove the batteries to avoid damage from battery leakage. If the batteries have leaked, remove them, wipe the battery compartment dry and replace the batteries with new ones.

**To remove the batteries**

Remove the lid as step 1 and take out the batteries.

**WARNING**

Battery may explode or leak if mistreated. Do not recharge, disassemble or dispose of in fire. Check the valid date (month-year) displayed on the batteries.

# Displaying Various Data

The unit can display various superimposed text data on an external monitor connected to the unit.

In this operation manual, the menu screen etc. is displayed in English. You can change the desired language with the screen language setting. For details, see page 53.

## Menu screen

Press MENU button to display the menu screen. You can change or check the menu item settings on this screen.

For details on the menu, see “Chapter 4 Adjusting and Setting Through Menus” on page 44.

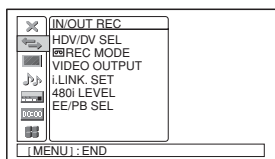

## Data display screen

You can check important information for normal recording or playback, such as time code or remaining tape time, on the screen.

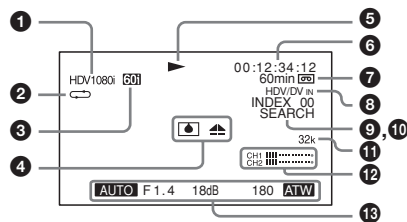

### 1 Format indicator

[HDV1080i], [DVCAM], or [DV SP] are displayed.

### 2 Repeat indicator

Displays the repeat indicator when [AUTO REPEAT] in [VTR SET] menu is set to [ON].

### 3 60i/50i indicator

### 4 Alarm indicator

Displays an alarm indicator.

For details on alarm indicators, see “Warning indicators and messages” on page 62.

### 5 Tape transport mode indicator

Displays the tape transport mode.

### 6 Time code indicator

In the drop frame mode, a period is displayed between the minutes and seconds (i.e., 00:12.58:00).

#### Note

When you play back a tape without having the time code set or the time code unrecognized on the unit cannot be displayed correctly.

### 7 Remaining tape time indicator

Displays the remaining tape time.

For details, see “[REMAINING]” on page 49.

#### Note

When you insert a cassette in which the tape has been rewound to the beginning, this indicator will not show the remaining tape time. The remaining tape time is displayed after the tape runs for a while.

### 8 INPUT SELECT indicator

Changes according to the position of INPUT SELECT switch ([HDV/DV IN], [S VIDEO IN], or [VIDEO IN]).

### 9 (Index) indicator

Displays [I] when an index has been marked.

### 10 Search indicator

Displays the search mode when you search for scenes using Remote Commander.

For details on the search function, see “Searching using the search function” on page 30.

### 11 Audio mode indicator

In the recording mode, displays 32k when you select [FS32K] for [AUDIO MODE] in [AUDIO SET] menu. When you select [FS48K], 48k is displayed.

During playback, displays the audio mode recorded on the tape. During i.LINK input, displays the audio mode of the signal input to [i] HDV/DV jack.

#### Notes

- The audio mode will not be displayed when [HDV/DV SEL] in [IN/OUT REC] menu is set to [HDV].
- Signals other than HDV/DVCAM lock mode will become non-standard audio and NS32k/NS48k is displayed during playback or when the signal is input from [i] HDV/DV jack.



---

## 12 Audio level meters

*For details of the audio level meter display, see “AUDIO MIX” in “AUDIO SET” menu on page 50.*

## 13 Date/time and camera data indicator

When you press DATA CODE button of Remote Commander or when you select [DATE] or [CAMERA DATA] of [DATA CODE] in [DISPLAY SET] menu, you can switch the display between recordings date/time and camera data.

*For details on the date/time and camera data indicator, see “Displaying information (data codes) recorded on a tape” on page 28.*

# Playback and Recording

## Notes on Power Supply and Video Cassettes

### Usable cassettes

We recommend you to use a DigitalMaster™ cassette of standard HDV/DVCAM/DV cassette (such as PHDV-276DM), or mini HDV/DVCAM/DV cassette (PHDVM-63DM) for recording in HDV/DV format. We recommend you to use a standard DVCAM cassette, Mini-DVCAM cassette, or DigitalMaster™ described above for recording in DVCAM format.

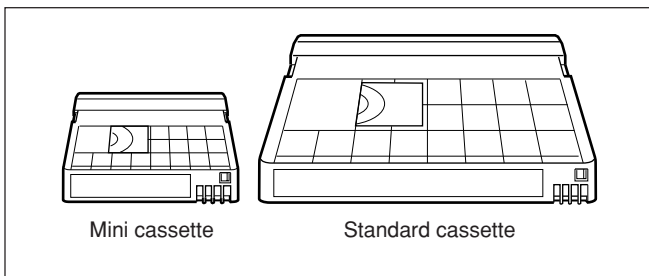

### Cassette memory

Some Mini cassettes and standard cassettes have the cassette memory (CIII mark). The unit, however, does not support cassette memory. However, if you use the DSR-25/45/50 as a recorder, the unit accesses cassette memory only if the recorder is set to [AUTO CIII].

### To save a recording

To prevent accidental erasure of a recording, set REC/SAVE switch on the cassette to SAVE. To record or dub audio on a tape, set the switch to REC.

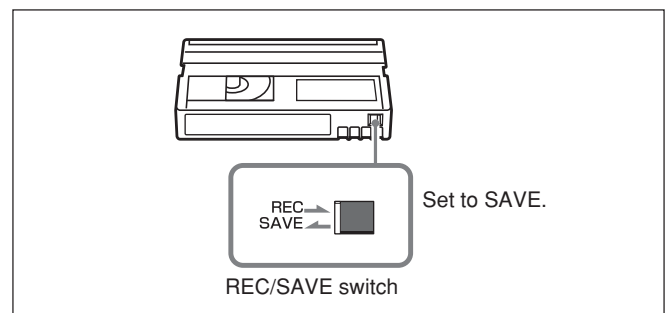

### Checking the tape for slack

Using a paper clip or a similar object, turn the reel gently in the direction shown by the arrow. If the reel does not move, there is no slack.

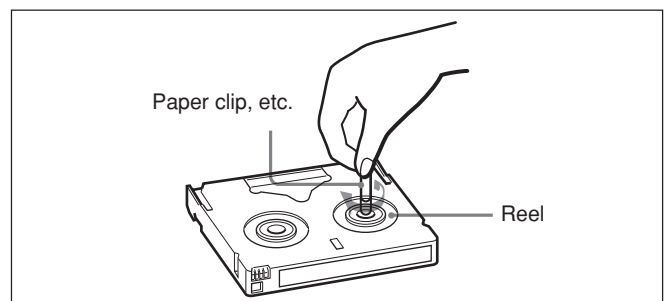

## Preparing the Power Supply

Connect the power cord (supplied) to the AC adaptor (supplied) and the DC plug of the AC adaptor to DC IN jack on the unit. Next, connect the power plug to an AC outlet. When you disconnect the power cord, be sure to unplug the power cord from the AC outlet first.

### PRECAUTION

Even if this unit is turned off, AC power (house current) is still supplied to it while connected to the wall outlet via the AC adaptor.

#### Notes

- Never short-circuit the DC plug of the AC adaptor with a metal object. A short circuit can damage the unit.
- Use a nearby wall outlet when using the AC adaptor. Disconnect the AC adaptor from the wall outlet immediately if any malfunction occurs.
- Do not use the AC adaptor placed in a narrow space, such as between a wall and furniture.

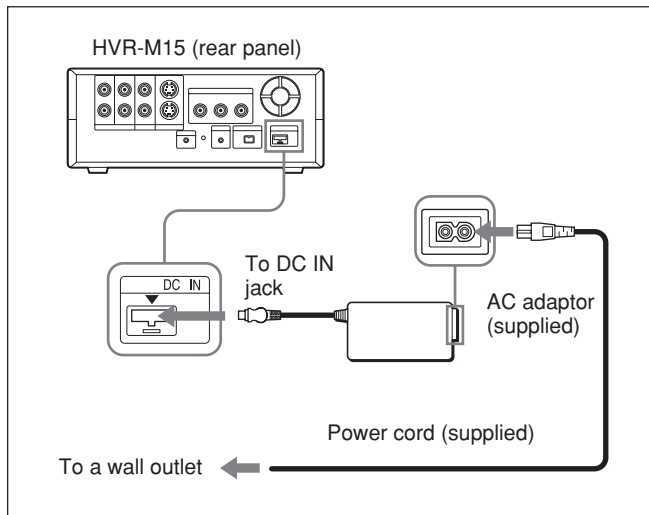

[CLOCK SET] screen appears when you turn on the unit for the first time.

Refer to page 54 on how to set the date and time.

## Inserting/Ejecting Cassettes

### To insert a cassette

#### Notes

- Do not insert the cassette forcibly. The unit may be damaged.
- Do not eject/load the cassette in a place subject to light. Close Cassette Lid when the unit is in use. The internal sensor of the unit may operate incorrectly if too much light falls on the unit.

- 1 With the unit powered on, confirm that  indicator is off, then open Cassette Lid.

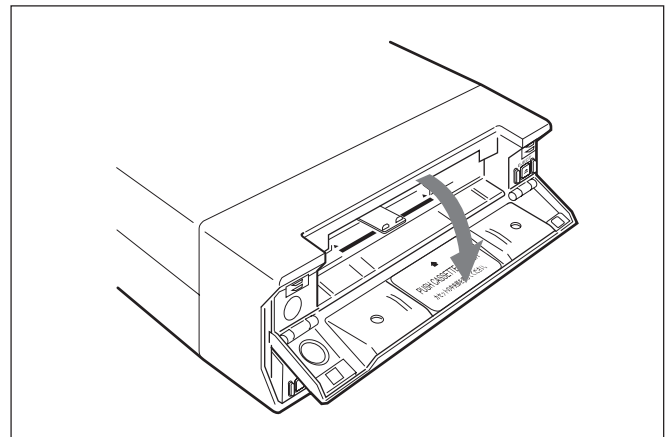

- 2 After checking the tape for slack, hold the cassette so that the tape window is facing upward, then insert it into the unit. The tape is inserted into the unit automatically.

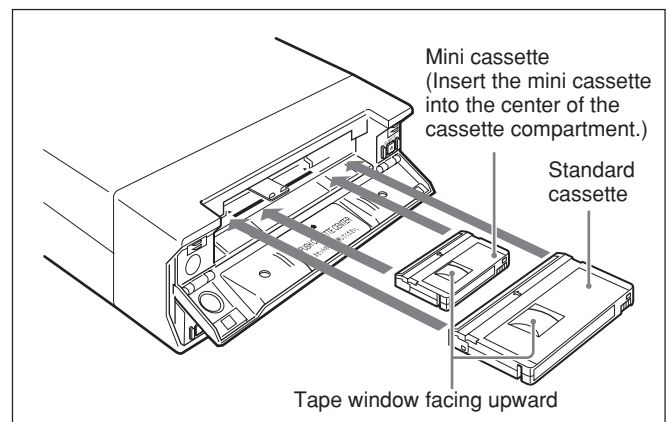

(Continued)

## Notes on Power Supply and Video Cassettes

### Notes

- When inserting a cassette, hold the back edge of the cassette in the center and push it until the cassette is inserted deep into the unit. If you hold the ends, the cassette may not be loaded properly.
- If the cassette does not load or is loaded only halfway, eject it once, and then insert it again. In such a case, if you insert the cassette forcibly, the cassette may not be loaded properly or malfunctions may occur.
- It takes a few seconds for the unit to recognize the cassette and find the proper location on the tape being loaded.

### 3 Close Cassette Lid.

#### To eject the cassette

- 1 With the unit powered on, open Cassette Lid. Press EJECT button located at the right side of the cassette compartment.

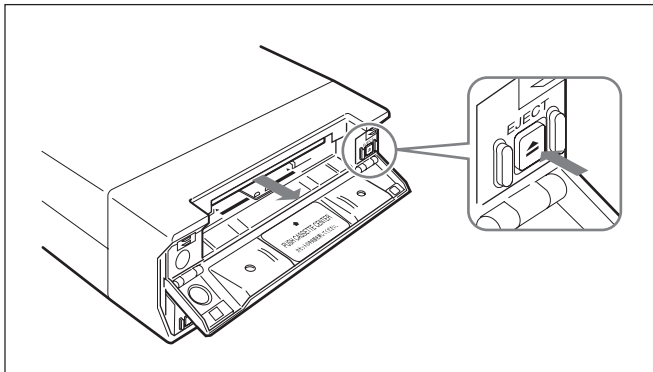

The cassette is unloaded and ejected.

- 2 Remove the cassette from the unit. Close Cassette Lid.

### Notes on Playback/Recording

#### No compensation for contents of the recording

Contents of the recording cannot be compensated for if recording or playback is not successful due to a malfunction of the unit, video tape, etc.

#### Copyright precautions

Television programs, films, video tapes, and other materials may be copyrighted. Unauthorized recording of such materials may be contrary to the copyright laws.

#### On recording

You cannot record or output EE signals to any software having copyright protection signals on the unit. If you start recording protected video and audio signals, a warning appears on the monitor screen and the unit stops recording.

During recording, do not change INPUT SELECT switch setting. If you do so, the unit may mistakenly recognize that a copyright control signal has been input.

#### On playback

When you play back software having copyright protected signals on the unit, you may not copy or output to other equipment.

#### Limitations caused by differences in format

The unit can record and play back tapes recorded in HDV (1080/60i, 1080/50i), DVCAM, or DV format. However, due to differences in format, you may not play back or edit some tapes affected by recording conditions of the tape (i.e., a tape originally recorded in DV format is dubbed in DVCAM format).

The unit cannot input/output, record, or play back a tape other than 1080/60i or 1080/50i format such as 1080/30F, 1080/25F, 1080/24F, 720/25p, 720/24p format.

The unit cannot input/output, record, or play back a tape with 4-channel audio signals in HDV extended format.

You can play back HDV720/30p format, while you cannot output the video signals from **Ⓜ** HDV/DV jack. For details, see “Compatibility of HDV, DVCAM, and DV Formats” on page 68.

If a tape has both a portion recorded in HDV/DVCAM format and one recorded in DV format (SP mode), the following limitations are applied when you play back the tape with the unit:

- The image may be distorted and noise may occur at the point where the recording format changes on the tape.
- The tape transport control buttons may be disabled until the tape speed is stabilized.

### Note on playback on other equipment

A tape recorded in HDV format using the unit cannot be played back with the devices not compatible with HDV1080i format. We recommend you to play back the tape for checking the contents before you actually play back the tape on other video equipment.

## Installing the Unit Vertically

Put the unit into the supplied rack as illustrated below. You can install it either standing on its left side or on its right side.

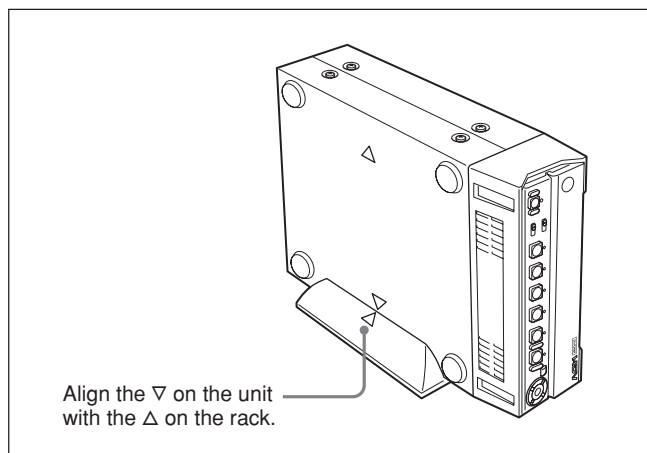

### Notes

- Be sure to use the supplied rack. Without the rack, the unit may topple over and may be damaged or may cause injury.
- Install the unit on a flat place.
- When inserting a cassette, hold the unit until it is loaded into the unit. Otherwise the cassette may fall out and the tape may be damaged.  
*For details on inserting a cassette, see “Notes on Power Supply and Video Cassettes” on page 20.*
- The name plate is located on the left side of the unit. You may not see it when using the supplied rack.

# Playback

This section describes the connections and settings for the playback and functions such as playback at various speeds and searching for a specific scene on a recorded tape.

## Connections for Playback

### Connecting the unit to a monitor without an i.LINK jack

You can connect the unit to video monitor without an i.LINK jack. Use the unit as follows.

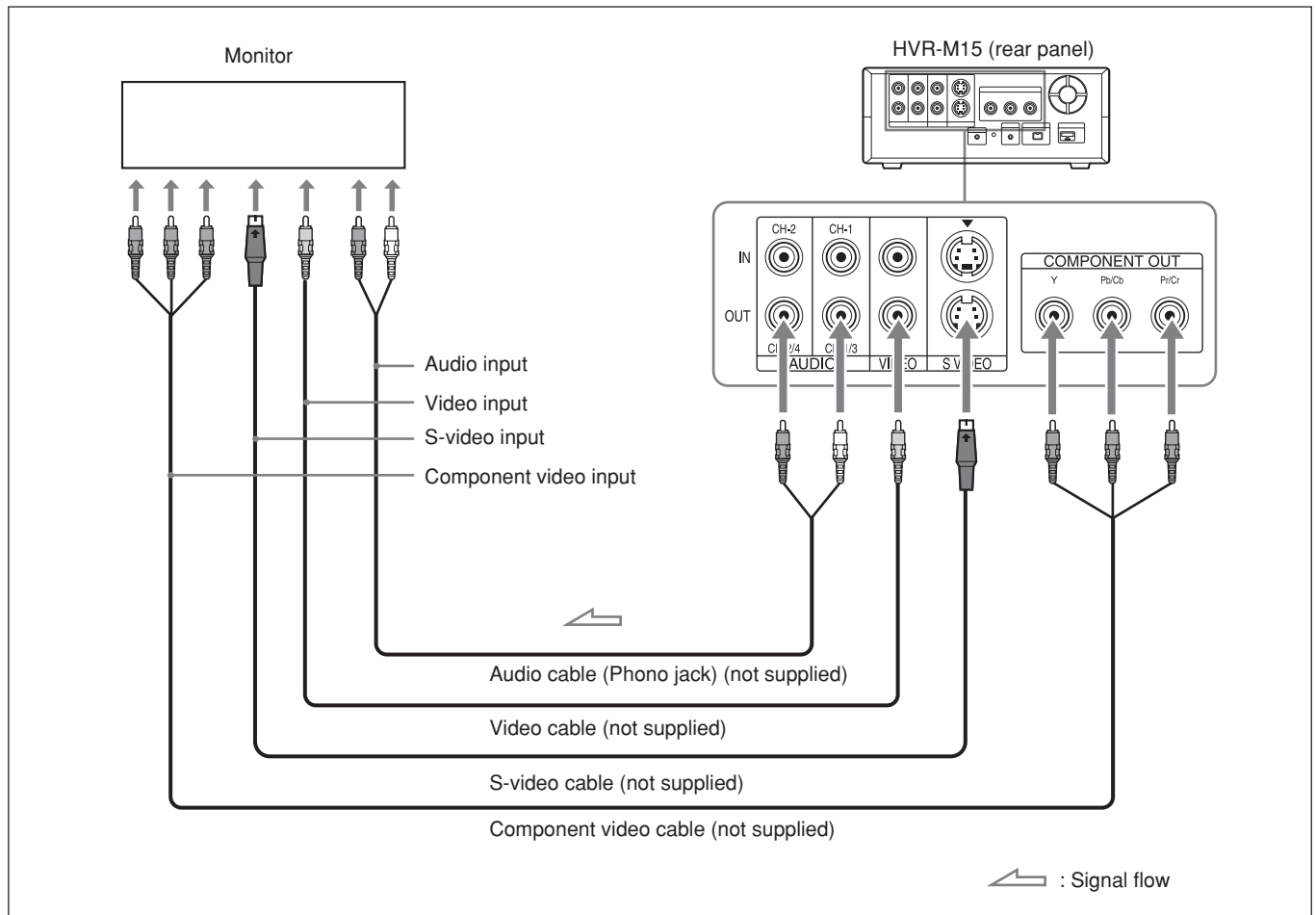



**Notes**

- To playback the picture recorded in HDV format when you connect the monitor using a component video cable, set [COMPONENT] of [VIDEO OUT] in [IN/OUT REC] menu according to your monitor (page 47). When the picture recorded in DVCAM/DV format is played back, only a picture with a quality equivalent with DVCAM/DV format of 480i (NTSC) or 576i (PAL) is output via COMPONENT OUT jacks regardless of [COMPONENT] setting.
- For details on output level from COMPONENT OUT jacks, see “Specifications” (page 75).
- To change the output level from COMPONENT OUT jacks, see [480i LEVEL] in [IN/OUT REC] menu (page 48).
- If you connect the input connectors of the unit to the output connectors of a monitor, a humming noise may be generated or the image may be distorted. If these phenomena occur, use INPUT SELECT switch to select a signal that is not being input or disconnect the cables.
- When you play back an HDV-formatted tape with copyright protected signals or input i.LINK signals with copyright protection to i.LINK jack, pictures may be output in either 480i (NTSC) or 576i (PAL) format regardless of the setting of [COMPONENT] of [VIDEO OUT] in [IN/OUT REC] menu.
- The unit cannot up convert DVCAM/DV recordings to HDV at output.

**Connecting the unit to a monitor equipped with an i.LINK jack**

The video and audio signals are sent with hardly any degradation, enabling high-quality playback to a monitor with an i.LINK connector which supports HDV, DVCAM, and DV format.

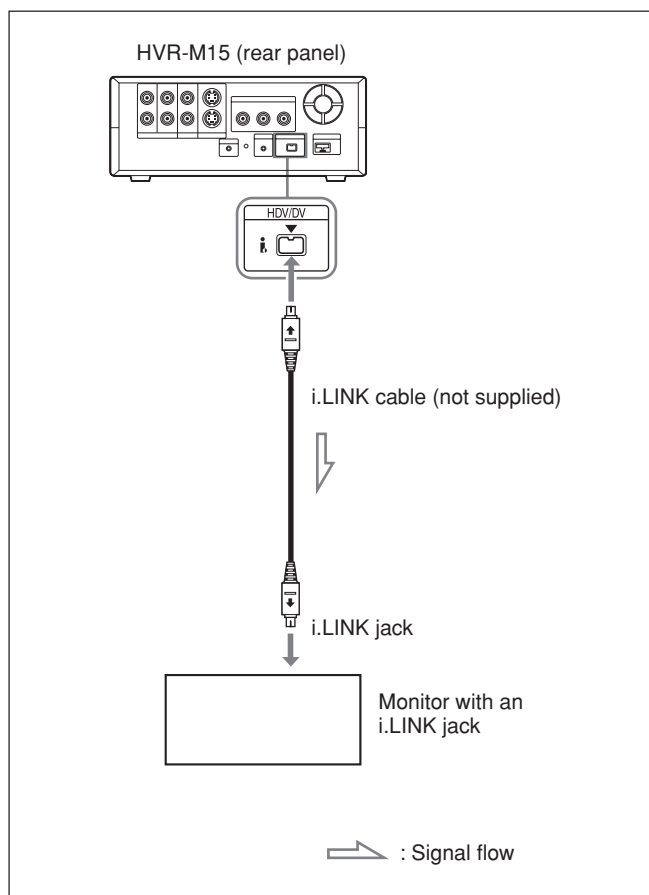
**Notes**

- Be sure that you set [HDV/DV SEL] in [IN/OUT REC] menu to [AUTO] (default setting) before connecting the video equipment to the unit with the i.LINK cable. If you change the setting after connecting the i.LINK cable, the monitor may not recognize the video signal correctly (page 46).
- To connect the unit to a monitor equipped with an i.LINK jack, you may need to adjust the monitor settings so that it recognizes the unit. For details, refer to your monitor's instruction manual.
- When i.LINK is connected, the unit cannot output video or audio only.

(Continued)

## Playback

---

- If you connect the input connectors of the unit to the output connectors of a monitor, a humming noise may be generated or the image may be distorted. If these phenomena occur, use INPUT SELECT switch to select a signal that is not being input or disconnect the cables.
- To connect i.LINK cable between a monitor and the unit, use an HDV or DV-compatible monitor. To playback a tape recorded in HDV mode on a DV-compatible monitor, set [HDV → DV CONV] of [i.LINK SET] in [IN/OUT REC] menu to [DVCAM] or [DV SP] before connecting the unit with the i.LINK cable.  
*For details, refer to your monitor's instruction manual.*
- Some general consumer television sets are provided with a function to control equipment connected with the i.LINK cable. Such a function, however, may not work with the unit.

## Settings for Playback

### Preparation on the unit

#### Notes

- Text information is superimposed to VIDEO OUT jack, S VIDEO OUT jack, and COMPONENT OUT jacks. To record video signals without text data, set DISPLAY OUTPUT switch to OFF (page 8).  
For details on text data, see “Displaying Various Data” on page 18.
- To view a tape recorded in HDV format by connecting the unit to a monitor set that has a 4:3 aspect ratio, set [DOWN CONVERT] of [VIDEO OUT] in [IN/OUT REC] menu to the desired mode (page 47).

**1** Power on the monitor, then set the monitor’s input switch according to the signals input.

**2** Turn the unit on.

## Playback Procedures

**1** Insert a cassette and confirm that  (cassette) indicator lights.

**2** Press PLAY button on the unit.

The unit starts playback.

### To stop playback

Press STOP button on the unit.

### To pause playback

Press PAUSE button on the unit.

#### Notes

- If the unit is playing a portion of a tape where the recording format changes between HDV, DVCAM, and DV, the picture and sound are distorted on such portions.
- You cannot play back an image recorded in DV (LP) mode on the unit.
- If the unit is playing a tape recorded with mixed video signals of the 60i system and 50i system, the picture and sound will be distorted on a portion of a tape where the recording system changes.
- During pause, the picture recorded on a tape in HDV format cannot be output from  HDV/DV jack.

## Playback Functions

This section describes useful functions during playback.

### Displaying information (data codes) recorded on a tape

If you record on a tape using a Sony digital HD video camera recorder or digital camcorder, the recording information (data codes) will be recorded on the tape. The data codes consist of recording date/time and camera data (the shutter speed, SteadyShot, iris, white balance, program AE mode, gain, date and time). You can check these data items during playback on the unit.

Each time you press DATA CODE button on Remote Commander, the display changes in sequence as follows:

no data code → recording date/time → camera data → no data code ..... Also, you can change the display by setting [DATE] or [CAMERA DATA] of [DATA CODE] in [DISPLAY SET] menu.

For details, see “DATA CODE” on page 49.

### Notes

- If the data codes were not recorded, “- -” appears instead.
- The unit cannot record camera data.
- Some of the camera data items displayed by the unit are different from those shown on the digital camcorder and digital HD video camera recorder.

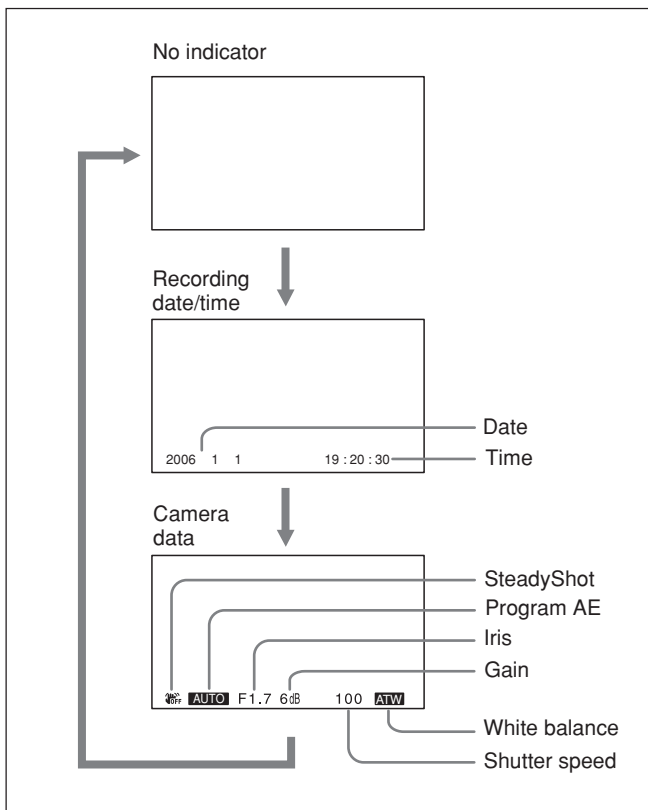

## Playing at various speeds

You can play back a tape at various speeds using Remote Commander.

### HDV-formatted tape

Button	Operation speed	Panel/analog output		i.LINK output	
		Forward direction	Reverse direction	Forward direction	Reverse direction
× 1/10	One-tenth of normal speed	⊙	—*	—	—*
× 1/3	One-fifth of normal speed	⊙	—*	—	—*
× 1	Playback at normal speed	⊙	○	⊙	○
× 2	Playback at normal speed	—*	—*	—*	—*
FRAME ◀   /  ▶	Frame-by-frame forward scanning	⊙	—*	—	—*
⏮/⏭	8× speed	○	○	○	○

\* The output will be the same as that of ×1.

⊙ : Play at normal speed.

○ : A search simple image is output. (Rough image)

— : No playback takes place.

### DVCAM/DV-formatted tape

Playback options	Operation
Play at 1/10 of normal speed	Press × 1/10 button during playback.
Play at 1/3 of normal speed	Press × 1/3 button during playback.
Play at normal speed	Press × 1 button during playback.
Play at twice the normal speed	Press × 2 button during playback.
Play frame by frame	Press FRAME ◀   /  ▶ buttons during pause. If you keep pressing one of these buttons, playback continues, frame by frame.
Fast forward the tape while monitoring pictures	Press ⏭ button during normal playback or when playing at various speeds.
Rewind the tape while monitoring pictures	Press ⏮ button during normal playback or when playing at various speeds.

### To change playback direction

Press FRAME ◀|||/||▶ buttons during normal playback or when playing at various speeds. To play back in the forward direction, press |||▶ button; in the backward direction, press ◀||| button.

#### Notes

- When the command mode of a Sony device/remote commander is set to VTR4:
  - if you press ×1/3 button on the supplied Remote Commander while pointing it toward a Sony device other than the unit, the playback speed may turn to 1/5 of normal speed.

- when you playback a tape in DVCAM/DV format and press ×1/5 button on Remote Commander while pointing it toward the unit, the playback speed turns to 1/3 of normal speed.
- If the unit keeps playing at 1/10 of normal speed in forward or reverse for more than 1 minute, the unit will begin to play back forward at normal speed.

# Playback

## To hear the sound while playing at various speeds

To hear the sound when playing at various speeds, set [JOG AUDIO] in [AUDIO SET] menu to [ON].

For details on [AUDIO SET], see "AUDIO SET" menu on page 51.

### Note

You cannot hear the sound while playing back a tape recorded in HDV format at various speeds.

## Searching using the search function

The unit can immediately access the following signals recorded on a tape.

- Searching for the beginnings of the recordings: Index search
- Searching for a point on the tape where the recorded date changes: Date search

To search for scenes, use the supplied Remote Commander.

- 1 Press SEARCH SELECT button on Remote Commander to select the search type.

The search type will change in the order of Index search → Date search → (No indication).

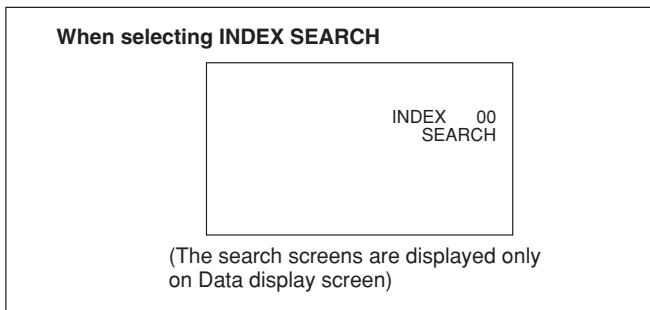

- 2 Press ◀◀ or ▶▶ button repeatedly to locate the scene you want.

Each time you press ◀◀ or ▶▶ button, the unit searches for the previous or next search point. When a search point is located, its number is indicated on the monitor screen.

The unit starts searching backwards or forwards until the number comes to zero, then plays back the scene.

## How signals are recorded

There are four different signal types, one for each search method; index, title, date and photo signals. The unit can record either index signals or date signals only on a tape.

### Notes

- If you record another program over the beginning of the search signals, you cannot locate the original program.

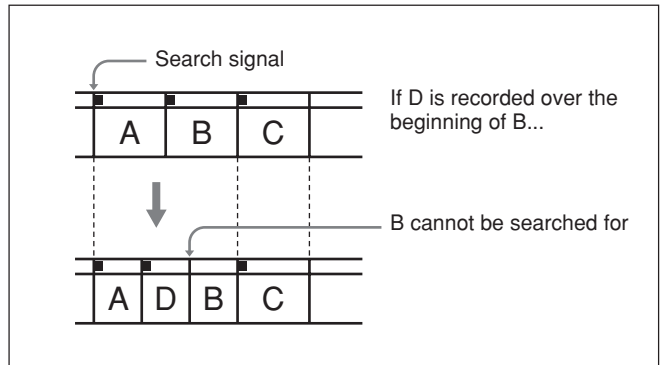

- The interval of a date or index must be 2 minutes or more. If the interval is short, the search signals may not be detected correctly.
- If non-recorded portions are included in the middle of a tape, signal search may not be performed correctly.
- You cannot add search signals after recording.
- The unit does not support reading and marking Index search signals on cassette memory. For duplicating with the DSR-25/45/50, see page 20.
- Searching may not be done correctly if the tapes were not recorded on Sony-brand digital video equipment.

## Auto Repeat

The unit can repeat the playback of all or a part of the tape.

- 1 Set [AUTO REPEAT] in [VTR SET] menu to [ON].
- 2 Press REW button (if the tape is already rewound, press PLAY button).

The unit rewinds the tape to its beginning, and starts playback automatically. When the following items on the tape are searched, AUTO REPEAT playback starts automatically.

- Index signals
- A portion unrecorded
- A portion recorded in the format set by other than [AUTO] in [HDV/DV SEL] in [IN/OUT REC] menu
- Tape end

### Auto Repeat using an external AC timer

If you connect an external AC timer (not supplied) to the unit, you can repeat playback automatically at the preset time.

- 1 Connect the unit to an external AC timer to the unit.

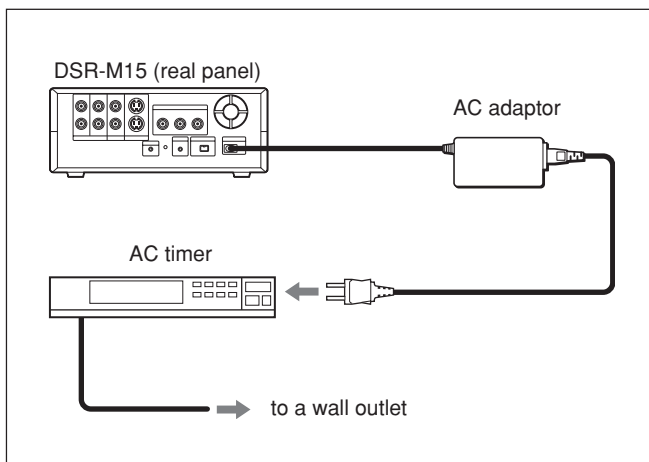

- 2 Set [AUTO REPEAT] in [VTR SET] menu to [ON].

↔ is displayed on the Data display screen (page 18).

- 3 Set the starting time on the external AC timer.

At the preset time, the power of the unit turns on, and after a few seconds (no more than 30), Auto Repeat playback starts automatically. When the following items on the tape are searched, AUTO REPEAT playback starts automatically.

- Index signals
- A portion unrecorded
- A portion recorded in the format set by other than [AUTO] in [HDV/DV SEL] in [IN/OUT REC] menu
- Tape end

### Notes

- The unit cannot search for an unrecorded portion for 20 seconds at the beginning of the tape until it searches for the next unrecorded portion throughout the tape.
- While a tape is running, be sure not to turn off the power by using an AC timer. The unit and the tape may be damaged. When turning off the power of the unit, make sure to press STOP button on the unit first to stop the tape transport, then turn off the power.
- The editing software used on the digital non-linear editing system may mark an index signal on a tape itself. Therefore, if you use a tape on which signals transmitted from a digital non-linear editing controller are recorded or a copy tape made from one, using digital dubbing, Auto Repeat may not be performed correctly.

### To stop Auto Repeat

Press STOP button on the unit.

### To release the Auto Repeat mode

Set [AUTO REPEAT] in [VTR SET] menu to [OFF].

# Using the Unit as a Videocassette Recorder

This section describes the connections, settings and operations necessary to perform recording on the unit. The same settings and operations apply whether you are using the unit for dubbing.

## Notes

- For connection of the editing devices, refer to the instruction manual of the editing controller and that of the editing software you use.
- Edit functions are specified by the editing software. For details on the editing methods, refer to the instruction manual of the editing software.  
*For details, see also pages 41, 42, 43.*

## Connections for Recording

### To video equipment without an i.LINK jack

You can connect the unit to video equipment without an i.LINK jack. Use the unit as a recorder as follows.

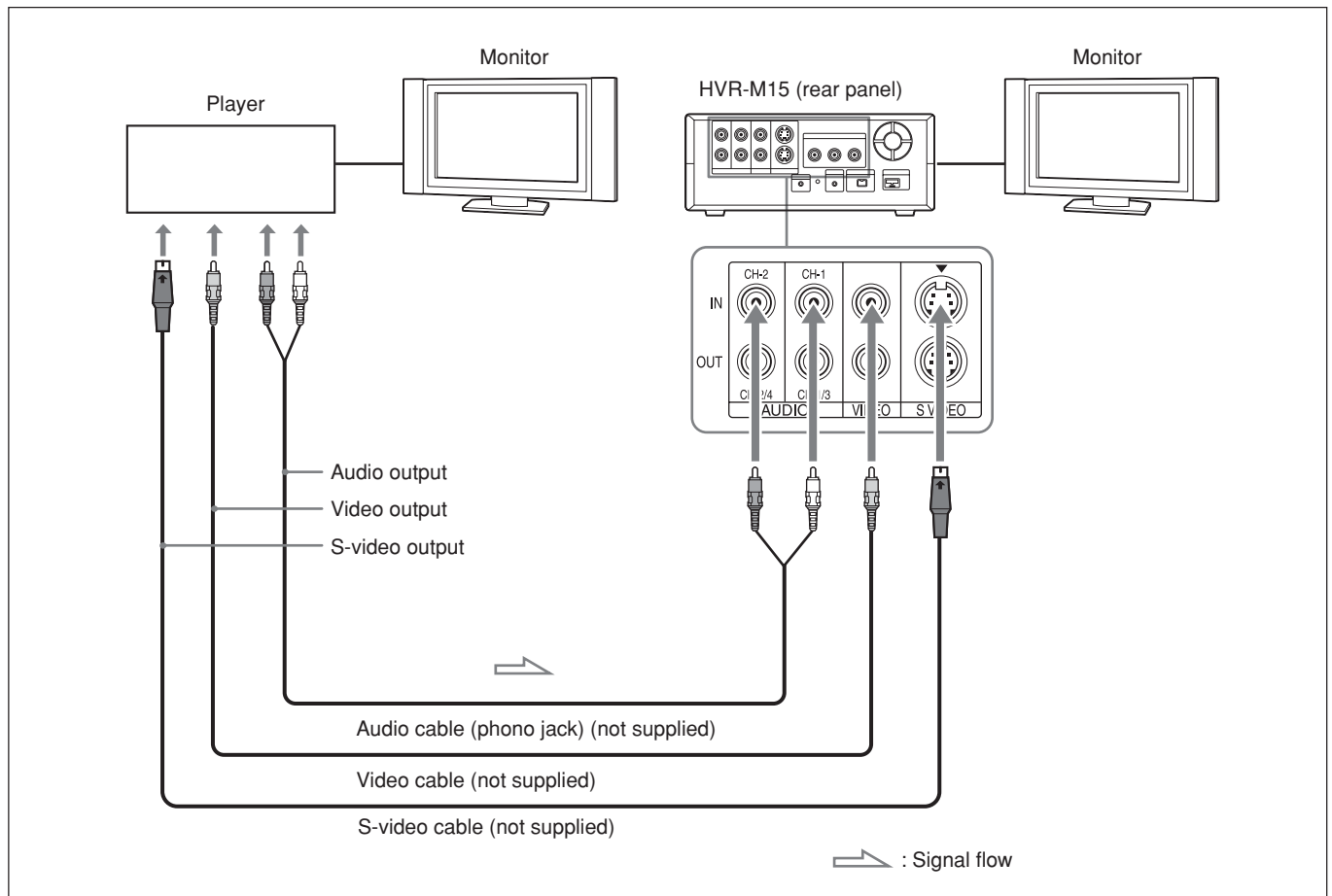

Connect either an S-video cable or a video cable.



**Notes**

- If you connect the output connectors of the unit to the input connectors of the player, a humming noise may be generated or the image may be distorted. If these phenomena occur, set INPUT SELECT switch to a position where a signal is not currently being input, or disconnect the cables.
- Distorted signals (i.e., when played back at a speed other than normal) may not be recorded or may be distorted.
- When you connect only AUDIO IN jacks when HDV indicator is lit, no audio is input. You must connect VIDEO IN jack at the same time or set [HDV/DV SEL] in [IN/OUT REC] menu to [DV].

**To digital video equipment with an i.LINK jack**

When you record i.LINK signal of HDV (1080/60i, 1080/50i), DVCAM, or DV format, the video and audio signals are sent without any degradation in quality, enabling high-quality recording. The signal flow is automatically detected so you do not need to make separate connections for input and output.

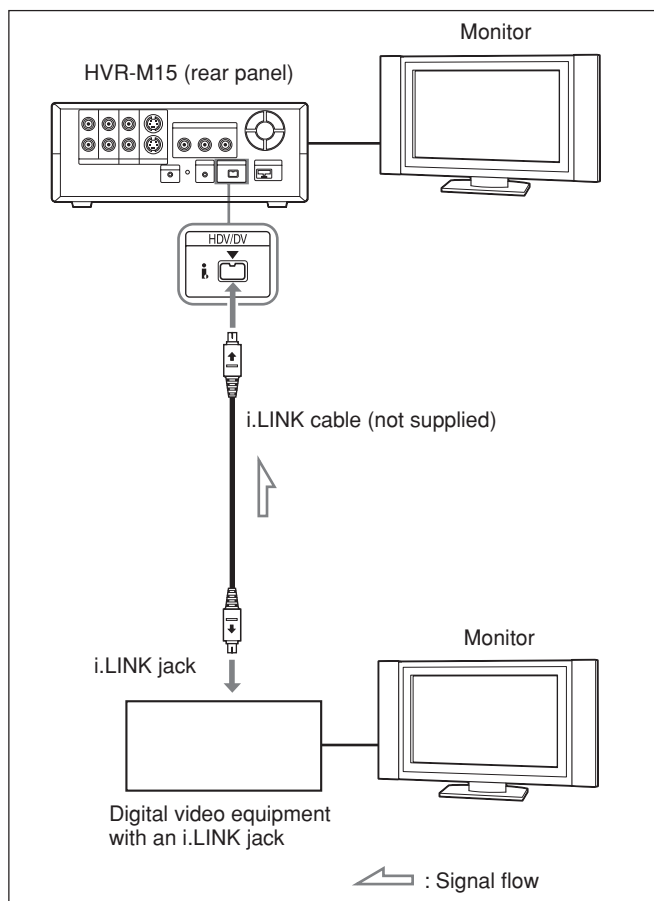
**Notes**

- When you record video from HDV-compatible equipment, set [HDV/DV SEL] in [IN/OUT REC] menu to [AUTO]. To record video from a DVCAM/DV equipment, set [HDV/DV SEL] in [IN/OUT REC] menu to [AUTO] or [DV] before connecting the i.LINK cable (page 46). If you change the setting after connecting the i.LINK cable, the video equipment may not recognize the video signals correctly.
- Copy-protected program such as digital broadcast cannot be input via i.LINK jack.
- With HDV/DV connection, the sound is recorded in the same audio recording mode as that of the source tape. To record in a different audio recording mode from the source tape, connect as shown in “To video equipment without an i.LINK jack” on page 32.
- With HDV/DV connection, data codes (recording date/time, camera data) recorded on the source tape are transmitted to the recorder (the unit). As a result, when you play back a recorded tape on the unit and press DATA CODE button on Remote Commander, the same data codes as those recorded on the source tape are displayed on the monitor screen.
- If no picture appears via i.LINK jack, disconnect the i.LINK cable, then reconnect it.
- If you record a picture in the playback pause mode, the image may be distorted.
- The unit cannot record video or audio separately.
- If you restart recording after a pause or stop, the images recorded before and after restarting operation will not be continuous.
- When connecting a device that has a 6-pin i.LINK jack to the unit, first, connect the plug of the cable to the 6-pin i.LINK jack.
- If the unit is connected to a device equipped with an i.LINK jack, when you intend to disconnect or reconnect the i.LINK cable, turn off the device and pull out the plug of its power cord from the AC outlet beforehand. If you connect or disconnect the i.LINK cable while the device is connected to the AC outlet, high-voltage current (8 to 40 V) is output from i.LINK jack of the device to the unit, which may cause a malfunction.
- If you connect the output connectors of the unit to the input connectors of a player or that of a monitor, a humming noise may be generated or the image may be distorted. If these phenomena occur, use INPUT SELECT switch to select a signal that is not being input or disconnect the cables.

*(Continued)*

# Using the Unit as a Videocassette Recorder

- The unit cannot record MPEG2 signals except HDV1080i signals.
- When you record HDV signals input from **i** HDV/DV jack, the connection between the recorded picture pauses for a second.

## Settings for Recording

### Preparation on the recorder (the unit)

#### Notes

- Before recording, set the date and time on the unit so that the recording time can be written into the search signal. You can set the date and time by setting [CLOCK SET] in [OTHERS] menu (page 54).
- Editing may not be possible with a signal that is copyright protected.
- During recording, the tape transport control buttons (except STOP and PAUSE) are disabled to prevent the tape running mode from being changed by an incorrect operation.

- 1** Turn the power on the monitor, then set the monitor's input according to the input signals.
- 2** Set up the player to play back a tape.  
*For details, refer to the instruction manual of the player.*
- 3** Turn the unit on.
- 4** When the player is connected to IN jacks on the unit, set [60i/50i SEL] in [OTHERS] menu according to the input signals.

When you input 60i system signals, set [60i/50i SEL] to [60i]. When you input 50i system signals, set [60i/50i SEL] to [50i] (page 55).

#### Notes

- Do not change [60i/50i SEL] setting during recording.
- When you select S VIDEO or VIDEO with INPUT SELECT switch, if the field frequency of the input signals is different from that of [60i/50i SEL] setting, the picture mutes.

- When the signals are input through the i.LINK interface, the unit detects the field frequency of the input signal automatically. You do not need to change [60i/50i SEL] setting. When [60i/50i SEL] is set to [50i], however, the time code generated by the unit is fixed to the non-drop frame mode. Even if 60i system signals are input to i.LINK jack, the time code generated by the unit is the non-drop frame mode, regardless of [TC FORMAT] setting in [TC/UB SET] menu. If you intend to record the unit to generate the time code in the drop frame mode, set [60i/50i SEL] to [60i].

- 5** Select an input signal by switching INPUT SELECT switch on the unit.

**HDV/DV** : to record input signals from **i** HDV/DV jack

**S VIDEO** : to record input signals from S VIDEO IN jack

**VIDEO** : to record input signals from VIDEO IN jack

You need to adjust [HDV/DV SEL] and [REC MODE] (page 46) in [IN/OUT REC] menu to your desirable recording format.

*For details of the recording tape format, see page 72.*

#### Note

Do not change INPUT SELECT switch setting during recording. If you change the setting of this switch during the recording, the recording will stop for several seconds. Recording will restart after the internal circuits are switched. During this time, no image is recorded.

- 6** If INPUT SELECT switch is set to S VIDEO or VIDEO, select the audio mode. (With a  HDV/DV connection, skip step 6, 7, and 8.)

When you select S VIDEO or VIDEO with INPUT SELECT switch, set AUDIO mode by setting [AUDIO MODE] in [AUDIO SET] menu (*page 50*).

**FS32K** : Switches the audio mode to 4-channel mode.

**FS48K** : Switches the audio mode to 2-channel mode.

When recording a tape in DV (SP), you can set AUDIO LOCK mode with [AUDIO LOCK] in [AUDIO SET] menu (*page 51*).

#### Note

When signals are input from  HDV/DV jack, those signals input to the recorder with the audio mode are the same as the signals input from the unit with the audio mode.

- 7** Select the recording level adjustment mode using [AUDIO AGC] in [AUDIO SET] menu.

#### Notes

- You cannot adjust recording level if you record signals input via  HDV/DV jack.
- For connecting the unit to a device that does not have an i.LINK jack, the sound is recorded on CH1/2 when the audio mode is set to [FS32K] (4-channel mode).

- 8** Adjust the audio recording level with [AUDIO REC LV] in [AUDIO SET] menu, if necessary (*page 50*).

You can adjust [AUDIO REC LV] only when you have selected [OFF] in step **7**.

Make sure not to exceed 0 dB at maximum volume, or sound distortion occurs.

#### Notes

- To record in DVCAM and DV (SP) format, there are two audio modes which you can select, with either 2-channels at FS48K or 4-channels at FS32K. It is not possible to select other modes (for example with 2-channels at FS32K).
- During recording, you cannot change the audio mode.

- If you intend to dub audio after recording, select whether [DVCAM] or [DV SP] of [REC MODE] in [IN/OUT REC] menu according to the unit you will use for audio dubbing. Then, set [AUDIO MODE] in [AUDIO SET] menu to [FS32K] (4-channel mode) before recording (*page 50*). (The unit does not have an audio dubbing function.)

# Using the Unit as a Videocassette Recorder

## Recording Procedures

This section describes the procedures used to record signals sent from another VCR to the unit. For details on the operation when the unit is connected to a computer via i HDV/DV jack, refer to “Editing (Connecting with a Computer)” (page 41).

- 1** Insert a cassette and confirm that  (cassette) indicator is lit.
- 2** Press the playback button on the player.  
  
The player starts playback.
- 3** On the unit, press PLAY button while holding REC button down.

### Note

When the unit records HDV format images, it takes a while until recording starts. This delay, however, is not a malfunction. ([STANDBY] and REC indicator on the Data display screen will blink until recording starts.)

### To stop recording

Press STOP button on the unit.

### To pause recording

Press PAUSE button on the unit.

### Note

You cannot up convert NTSC or PAL signals in HDV format for recording.

## Recording Functions

### Marking an index

By pressing INDEX WRITE button on Remote Commander during recording, you can mark an index signal at any place on the tape. If you mark an index at the scene you want to search for, you can easily find the scene later.

When [AUTO INDEX] in [VTR SET] menu is set to [ON], if you start recording while the tape in stop, the unit automatically marks an index. While the index is being marked,  indicator appears for about seven seconds on the Data display screen (page 18).

### Notes

- You cannot mark a new index while  indicator is being displayed.
- If you record on a portion of the tape where an index has been marked, the index will be erased. You cannot delete just an index while keeping the image or sound.
- You cannot mark an index during playback operations. INDEX WRITE button is disabled in these operations.

### To use an index during playback

See “Searching using the search function” on page 30.

# Dubbing/Editing

## Dubbing to another equipment

The section describes the connections and settings necessary to perform dubbing on other equipment, using the unit as a video player.

### Connections for Dubbing

#### To digital video equipment with an i.LINK jack

Connect the unit to the recorder as shown right using an i.LINK cable.

The signal flow is automatically detected so you do not need to make separate connections for input and output. Also, connecting the unit to an editing controller via **i** HDV/DV jack, you can configure a digital non-linear editing system.

*For connections of the editing controller and the unit, refer to the editing controller instruction manual.*

Before dubbing, you must set the format in which you want to output signals. Perform [HDV/DV SEL] (page 46) and [i.LINK SET] (page 47) settings in [IN/OUT REC] menu.

*For details, refer to “Compatibility of HDV, DVCAM, and DV Formats” (page 68).*

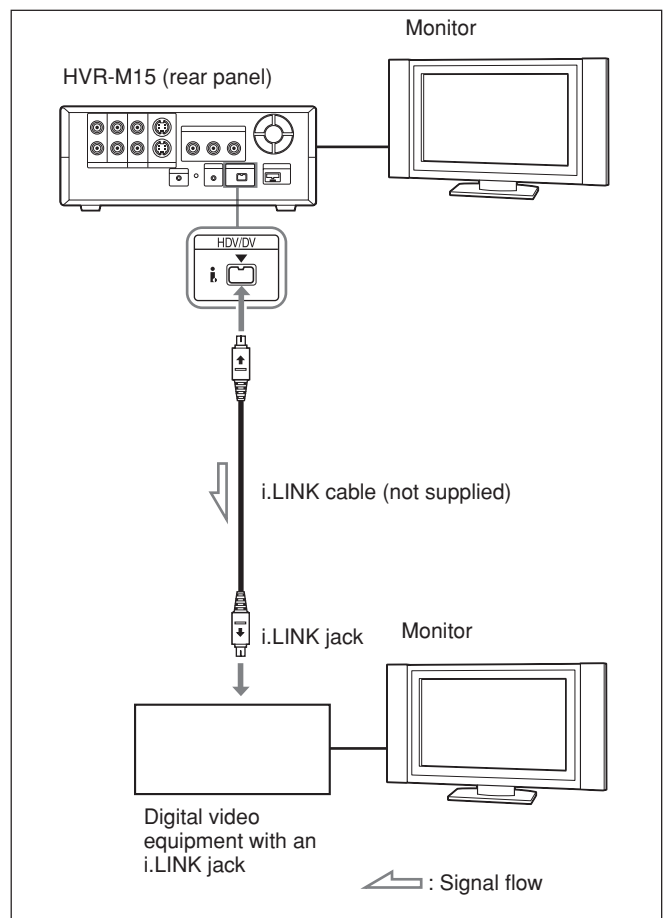

(Continued)

## Dubbing to another equipment

---

To dub a tape recorded in HDV format using duplicate function on such as the DSR-25/45/50, select [DVCAM] in [HDV → DV CONV] of [i.LINK SET] in [IN/OUT REC] menu.

There are some limitations to down convert a tape recorded in HDV format to DVCAM format.

For details, see “i.LINK SET” on page 47.

### Notes

- If you output pictures in the playback pause mode when connected with an i.LINK cable, recorded images may appear distorted.
- When the tape is recorded in HDV format, the picture is output as a simplified picture for Search in the playback pause mode or during playback in various speeds (page 29).
- When connected with an i.LINK cable, you cannot output only pictures or sounds separately.
- For details on the compatibility of various formats, the supplied “Compatibility of HDV, DVCAM, and DV Formats” (page 68 - 72).

## To video equipment without an i.LINK jack

When connecting the unit to a recorder without an i.LINK jack, connect the two devices as shown below. Set [COMPONENT] and [DOWN CONVERT] setting of [VIDEO OUT] in [IN/OUT REC] menu (page 47) corresponded to the signals you wish to output.

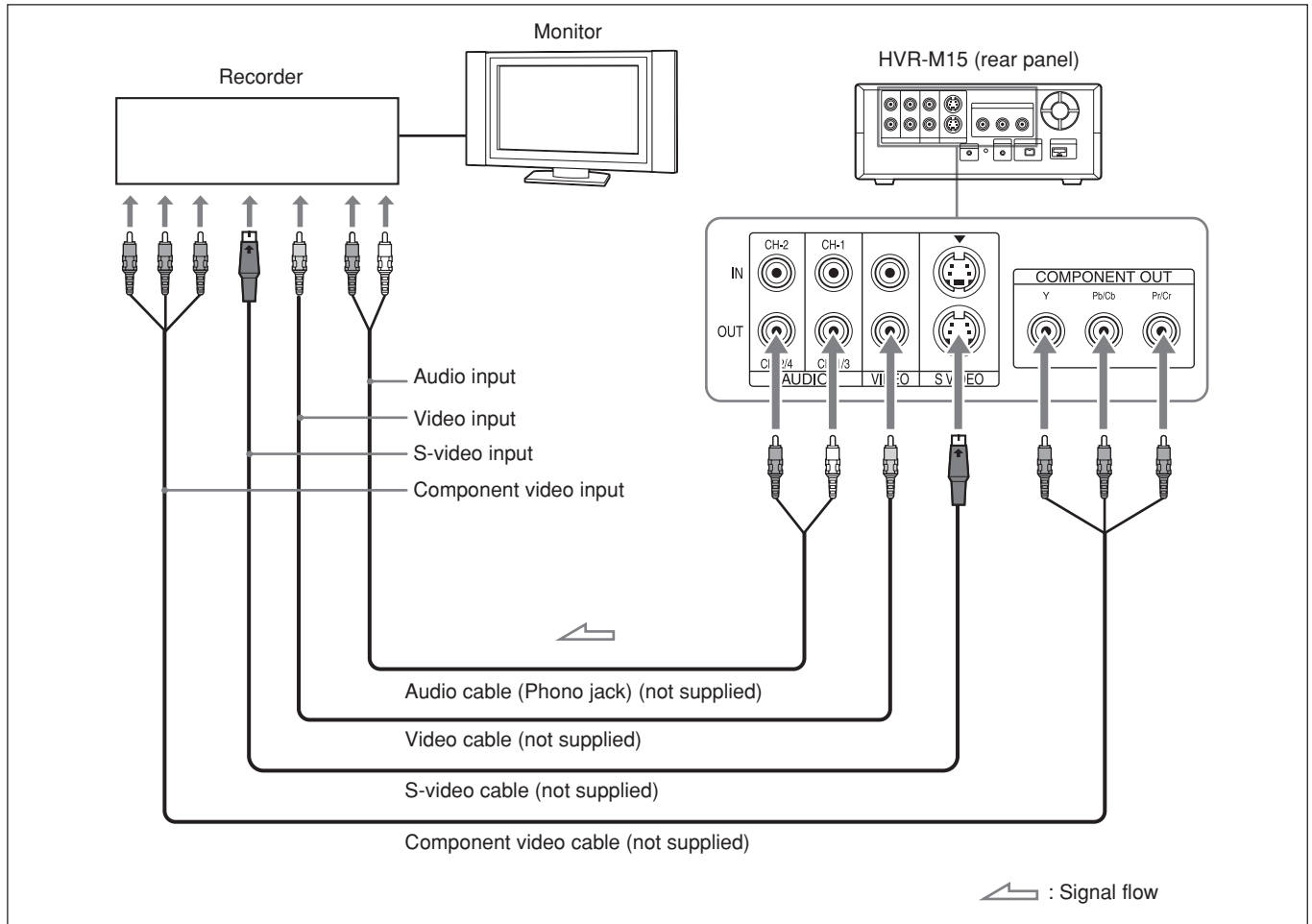

### Notes

- Refer also to the Notes on page 25.
- The audio output signal is selected by the setting of [AUDIO MIX] in [AUDIO SET] menu.

# Dubbing to another equipment

---

## Dubbing procedures

- 1** Prepare the unit.

*Refer to “Settings for Recording” on page 34.*

- 2** Prepare the recorder.

If the recorder has an input selector switch, select an input.

*For details, refer to your recorder’s instruction manual.*

- 3** Start playback on the unit and start recording on the recorder.

*For details, refer to your recorder’s instruction manual.*

- 4** When dubbing is finished, stop recording on the recorder, and then stop playback of the unit.





# Editing (Connecting with a Computer)

You can set up an editing system by connecting the unit to a computer (editing machine) using **i** HDV/DV jack on the unit.

- For details about the connecting method to the editing machine, refer to the supplied instruction manual of your editing unit.
- The editing functions you can use depend on the editing software. For details about editing methods, refer to the instruction manual of your editing software.

## Connecting the Unit to a Computer

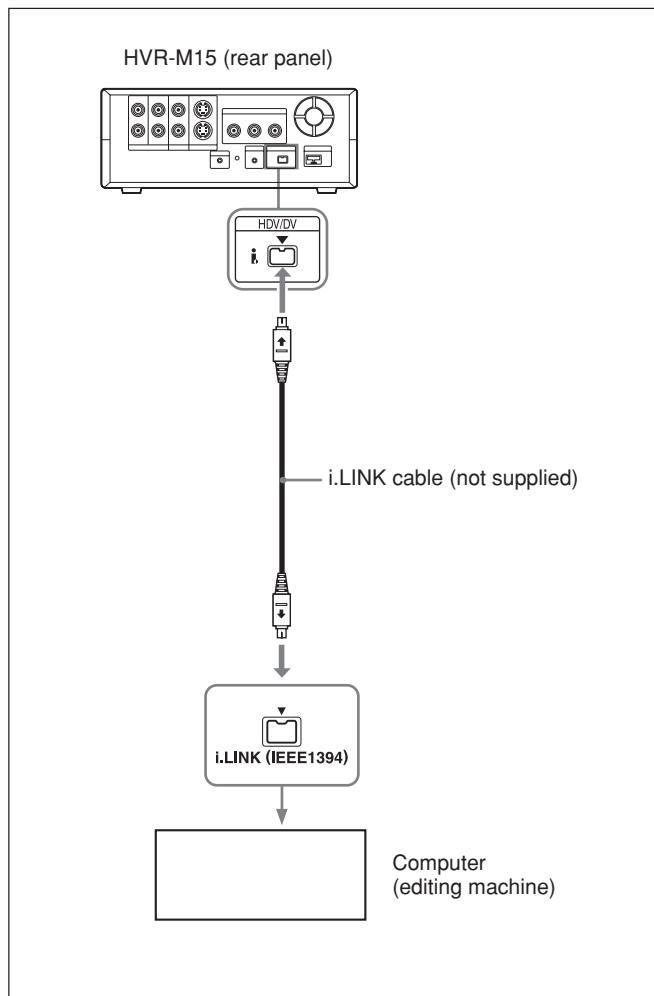

### Notes

- Be sure to connect the i.LINK cable to a computer (editing machine) first and then connect it to the unit. If you connect the i.LINK cable to the unit first, it may cause the unit to malfunction because of static electricity.
- If no picture appears via **i** HDV/DV jack, disconnect the i.LINK cable, then reinsert it straight.
- If the unit is connected to a device equipped with an i.LINK jack, when you intend to disconnect or reconnect the i.LINK cable, turn off the device and pull out the plug of its power cord from the wall outlet beforehand. If you connect or disconnect the i.LINK cable while the device is connected to the AC outlet, high-voltage current (8 to 40 V) is output from i.LINK jack of the device to the unit, which may cause a malfunction.
- Before connecting the i.LINK cable, set [HDV/DV SEL] and [i.LINK SET] in [IN/OUT REC] menu. If you perform the settings after connecting the cable, the computer (editing machine) may not recognize the unit correctly or may freeze.
- If you input or output signals in a format incompatible with the computer (editing machine), the computer may not recognize the unit correctly or may freeze.
- When set to EE mode, the unit outputs analog signals those are input from **i** HDV/DV jack to a computer. S Video or VIDEO signals are output from **i** HDV/DV jack, according to the setting of INPUT SELECT switch. To output the playback image from the unit through **i** HDV/DV jack only, set INPUT SELECT switch to HDV/DV.

### Preparations

#### Transferring the picture data from the unit to a computer (editing machine)

- To transfer the picture data recorded on a tape to an editing machine in HDV, set [HDV/DV SEL] in [IN/OUT REC] menu to [HDV] (page 46), then set [HDV→DV CONV] of [i.LINK SET] in [IN/OUT REC] menu to [OFF] (page 47).
- To transfer the picture data recorded on a tape in DVCAM (DV) to an editing machine, set [HDV→DV CONV] of [i.LINK SET] in [IN/OUT REC] menu to [OFF] (page 47).
- To transfer the picture data recorded on a tape in HDV to an editing machine in DVCAM (DV), select [DVCAM] or [DV SP] in [HDV → DV CONV] of [i.LINK SET] in [IN/OUT REC] menu, then set [DOWN CONVERT] (page 47).

#### Notes

- The operation may not work with some of your editing machine software. Before using the software, confirm that it is compatible with the unit.
- The unit cannot up convert a tape recorded in DVCAM (DV) format to HDV format when transferring the picture data to an editing machine.
- If you mix a tape recorded both in HDV and DVCAM (DV) formats mixed when [HDV/DV SEL] is set to [AUTO], the computer (editing machine) may not recognize the unit or you may not edit the tape correctly.
- There are restrictions on the video output when you play back a tape recorded in HDV format at various speeds. Refer to the table for “HDV-formatted tape” in “Playing at various speeds” (page 29).
- When you use a tape that was down converted from HDV to DVCAM or DV, some conventional DVCAM/DV editing software may not perform the time code search or this operation could result in an error.
- When you record HDV signals that are input through **i** HDV/DV jack, a connecting portion between scenes on the tape will be displayed as a still picture for approximately 1 second. We recommend you to perform digital nonlinear editing.

- If the editing software used has the capability to output the time code as well as the video and audio signals to the unit, and you intend to record that time code, set [HDV/DV IN TC] in [TC/UB SET] menu to [EXTERNAL].

*For details on [TC/UB SET] menu, see “TC/UB SET” menu on page 52.*

- When [HDV/DV IN TC] in [TC/UB SET] menu is set to [EXTERNAL], if you input time code to the **i** HDV/DV jack that is not continuous or does not advance correctly, the value of the recorder or displayed time code may not be equal to the actual value of the input one. If you use a tape recorded under such condition, you may not perform search or edit the picture, depending on the device you use.
- For connection of the editing controller and its peripheral devices, refer to the instruction manual of the editing controller and that of the editing software you use.
- Edit functions are specified by the editing software. For details on the editing methods used, refer to the instruction manual of the editing software.
- The unit has a function to down convert HDV signals to DVCAM (DV) signals to output from **i** HDV/DV jack. Some software may not edit DVCAM/DV signals that are down converted from HDV signals correctly. In this case, follow the procedures below for tape duplication, then use the duplicated tape when editing the picture.

#### Creating a DVCAM compatible tape

Set [HDV → DV CONV] of [i.LINK SET] in [IN/OUT REC] menu to [DVCAM] (page 47), then perform DVCAM recording using a recording device that accepts DVCAM format.

#### Creating a general consumer DV compatible tape

Set [HDV → DV CONV] of [i.LINK SET] in [IN/OUT REC] menu to [DV SP] (page 47), then perform DV recording using a recording device that accepts DV format.

---

## Transferring the picture data on a computer (editing machine) to the unit

- To transfer the picture data recorded on a tape to an editing machine in HDV, set [HDV/DV SEL] in [IN/OUT REC] menu to [HDV], then set [HDV → DV CONV] of [i.LINK SET] in [IN/OUT REC] menu to [OFF] (*pages 46, 47*).
- To transfer the picture data to a computer (editing machine) in DVCAM (DV) format, set [HDV/DV SEL] to [DV] (*page 46*). Then, according to the desired recording format, set [REC MODE] to [DVCAM] or [DV SP] (*page 46*). Also, according to your edit software, select [DVCAM] or [DV SP] in [HDV → DV CONV] of [i.LINK SET] in [IN/OUT REC] menu (*page 47*).

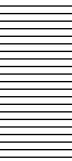

# Adjusting and Setting Through Menus

## Operating the Menus

The unit allows you to set various parameters in the menus. Before you start using the unit, set the internal clock in [CLOCK SET] in [OTHERS] menu. Except for clock setting, you can use all other factory-set default parameters but change them as needed.

### Notes

- Do not pull out the power cord plug while operating the menus. Otherwise, the settings of the menu may be changed accidentally.
- If the internal backup battery is exhausted, the time set in the internal clock and [60i/50i SEL] setting will be initialized. The internal backup battery is fully charged if you connecting the power to the unit for about 24 hours. A fully charged internal battery can run for about 3 months.

### Displaying the menu

- 1** Press MENU button.
- 2** Pressing  $\uparrow/\downarrow$  buttons, select the menu icon you want to change, then press EXEC button.
- 3** Pressing  $\uparrow/\downarrow$  buttons, select the submenu you want to change, then press EXEC button.
- 4** Pressing  $\uparrow/\downarrow$  buttons, change the setting.
- 5** Press EXEC button to return to the submenu.
- 6** Repeat steps **1** to **5**, as needed.

To return to the previous menu level, press  $\uparrow/\downarrow$  buttons and select [ $\rightarrow$  RETURN].

You can use  $\leftarrow/\rightarrow$  buttons to move the menu cursor and to adjust increase/decrease settings.

## Menu Organization

The menu of the unit consists of the following menus and submenus.

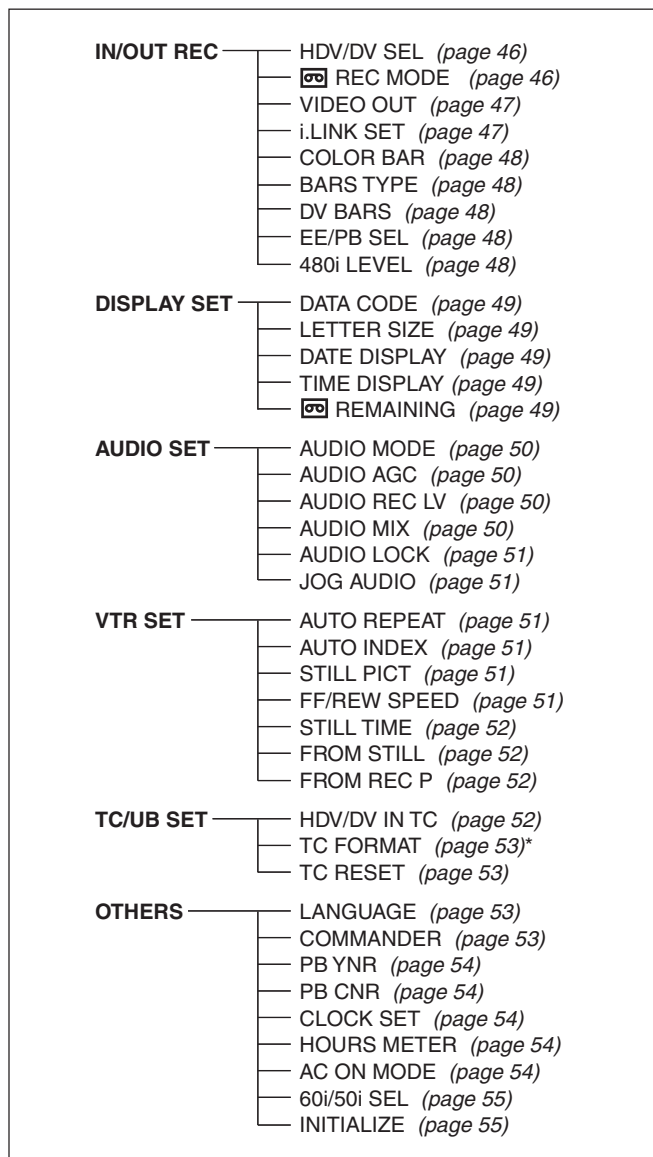





\* available only when you use a 60i formatted signal



# Operating the Menus

## Menu Contents

Initial settings are indicated with rectangles.

### IN/OUT REC menu

Icon/Menu	Submenu	Setting
↔ IN/OUT REC	HDV/DV SEL (pages 25, 33, 37, 41)	<p>Normally, set this menu to [AUTO]. Select this menu when you want to limit the output format during tape playback or limit the signals to be input or output from  HDV/DV jack. This setting will affect analog outputs.</p> <p><b>AUTO</b> : Automatically switches signals to HDV format or DVCAM/DV format during tape playback. When the i.LINK cable is connected, the signals in HDV format or DVCAM/DV format are switched automatically and signals from  HDV/DV jack will be input/output for recording/playback.</p> <p><b>HDV</b> : Outputs portions of signals recorded in HDV format during tape playback. When the i.LINK cable is connected, only the signals in HDV format from  HDV/DV jack are input/output for recording/playback. Also, select this setting when the unit is connected to the i.LINK cable to a computer supporting HDV format (see pages 25, 41).</p> <p><b>DV</b> : Outputs signals of portions recorded in DVCAM/DV format during tape playback. When the i.LINK cable is connected, only the signals in DVCAM/DV format from  HDV/DV jack are input or output for recording/playback. Also select this setting when the unit is connected to the i.LINK cable to a personal computer that supports DV format (see pages 25, 41).</p> <p><b>Notes</b></p> <ul style="list-style-type: none"> <li>• Before changing the setting, be sure to disconnect the i.LINK cable, or turn the other device off. If an i.LINK cable is connected when you change the setting, the video equipment may not be able to recognize the signal correctly.</li> <li>• If you select [AUTO], the screen turns off temporarily when HDV signals are switched to DVCAM/DV signals or vice versa. The video and audio also stops at the same time.</li> <li>• For details of the i.LINK output and the recording tape format, see page 71.</li> </ul>
	 REC MODE	<p>Switches the recording mode between DVCAM and DV format (SP mode only).</p> <p><b>DVCAM</b> : Records in DVCAM format.</p> <p><b>DV SP</b> : Records in DV format (SP mode).</p> <p><b>Note</b></p> <p>You cannot change the setting during recording.</p>

Icon/Menu	Submenu	Setting
↔ IN/OUT REC	VIDEO OUT	<p>Selects the mode of video output jacks.</p> <p><b>COMPONENT</b> Selects the output format from COMPONENT OUT jacks. Selects from [480i], [480p/480i] or [1080i/480i] when [60i/50i SEL] in [OTHERS] menu is set to 60i. Selects from [576i], [576p/576i] or [1080i/576i] when [60i/50i SEL] in [OTHERS] menu is set to 50i.</p> <p><b>DOWN CONVERT</b> Selects the setting for down converting images output from analog video jacks when playing back in HDV format or inputting HDV signals from  HDV/DV jack.</p> <p><b>SQUEEZE</b> : Maintains the image vertically and horizontally by compressing the horizontal ratio. Images appear vertically long.</p> <p><b>LETTER BOX</b> : Maintains the image vertically by compressing the vertical ratio.</p> <p><b>EDGE CROP</b> : Maintains the original image size and crops the left and right edges of the images.</p> <p><b>Notes</b></p> <ul style="list-style-type: none"> <li>• When you play back an HDV-formatted tape with copyright protected signals, or input HDV format with copyright protected signals, COMPONENT OUT jacks will output pictures in either 480i or 576i format.</li> <li>• Regardless of the playback tape or of the format input to , HDV/DV jacks, the selectable setting values displayed on this menu vary depending on the setting of [60i/50i SEL].</li> <li>• WSS (Wide Screen Signaling) is not output, when the picture is output to COMPONENT OUT jacks in 480p or 576p. Set the monitor according to the down convert format of the picture, which is output from the unit.</li> <li>• When you play back a tape in DVCAM or DV while an EE picture in NTSC/PAL is displayed, the 480i resolution or the 576i resolution is output, regardless of the setting of [COMPONENT] in [VIDEO OUT] in [IN/OUT REC] menu.</li> </ul>
	i.LINK SET (pages 25, 37)	<p>Adjusts the down conversion format. This menu is available when [HDV/DV SEL] is set to [AUTO] or [HDV].</p> <p><b>HDV → DV CONV</b></p> <p><b>OFF</b> : Disables down conversion.</p> <p><b>DVCAM</b> : Down converts to DVCAM format.</p> <p><b>DV SP</b> : Down converts to DV SP format.</p> <p><b>DOWN CONVERT</b> This setting is available when [HDV → DV CONV] is set to [DVCAM] or [DV SP].</p> <p><b>SQUEEZE</b> : Plays back with compressed horizontal screen image and maintains all images on display. Images appear vertically long.</p> <p><b>EDGE CROP</b> : Plays back with both left and right sides of the screen images cut off and maintains the original image appearance.</p> <p><b>Notes</b></p> <ul style="list-style-type: none"> <li>• When [DVCAM] is selected, there are some limitations described below. <ul style="list-style-type: none"> <li>– ATN (Absolute Track Number) outputs the value counted in DVCAM format during playback at regular speed (×1) or recording of the internal color bars only. During playback at irregular speeds other than described above, ATN outputs the value of a tape recorded in HDV format.</li> <li>– When the unit is playing back at regular speed (×1) while detecting a blank portion on the tape, the unit counts the blank portion as ATN formatted in DVCAM.</li> <li>– When using the duplicating function that is equipped with a device such as the DSR-25/45/50, select [DVCAM].</li> <li>– Please note that a duplicated tape and the source tape recorded in HDV format with [DVCAM] selected do not share the same ATN (Time code value is displayed correctly).</li> </ul> </li> <li>• When you change the video format setting of [DOWN CONVERT] of [i.LINK SET] in [IN/OUT REC] menu, the video signal output from COMPONENT OUT jacks, S VIDEO jack, or VIDEO OUT jack may be distorted for a moment.</li> <li>• Before changing your setting, be sure to disconnect the i.LINK cable. If you change the setting while i.LINK is connected, the video device may not recognize the new setting.</li> </ul>



(Continued)

# Operating the Menus

Icon/Menu	Submenu	Setting
↔ IN/OUT REC	COLOR BAR	<p>Selects whether to display color bars or not. Also, you may select color bars with or without tone signals (1 kHz full bit –20 dB at 60i, 1 kHz full bit –18 dB at 50i).</p> <p><b>[OFF]</b>: Does not display color bars and no tone signals.  <b>ON</b>: Displays color bars without tone signals.  <b>ON [TONE]</b>: Displays color bars with tone signals.</p> <p><b>Notes</b></p> <ul style="list-style-type: none"> <li>• Color bars and tone signals are output from <b>i</b> HDV/DV jack and analog output jacks.</li> <li>• Color bars and tone signals cannot be output when the tape is in playback mode.</li> <li>• The color bars output to i.LINK/the color bars recorded on tone signals and tapes/the format of tone signals can be set by [HDV/DV SEL] and [ <b>REC</b> MODE]. <ul style="list-style-type: none"> <li>– When [HDV/DV SEL] is set to [AUTO], the format of the color bar and tone signals will be output/recorded according to the video format displayed in “<b>1</b> Format indicator” (page 18) of text data display on a monitor.</li> <li>– When [HDV/DV SEL] is set to [HDV], color bars and tone signals are output/recorded in HDV format.</li> <li>– When [HDV/DV SEL] is set to [DV] and [ <b>REC</b> MODE] is set to [DVCAM], color bars and tone signals will be output/recorded in DVCAM format.</li> <li>– When [HDV/DV SEL] is set to [DV] and [ <b>REC</b> MODE] is set to [DV SP], color bars will be output/recorded in DV (SP) format.</li> </ul> </li> <li>• When the unit turns off and on again, [COLOR BAR] is automatically set to [OFF].</li> </ul>
	BARS TYPE	<p>Selects the type of color bars.</p> <p><b>[TYPE 1]</b>: Outputs TYPE 1 color bars.  <b>[TYPE 2]</b>: Outputs TYPE 2 color bars.  <b>[TYPE 3]</b>: Outputs TYPE 3 color bars.</p> <p><b>Notes</b></p> <ul style="list-style-type: none"> <li>• When color bars are output in NTSC (60i) mode on the unit, no-setup (0 IRE) signals are output.</li> <li>• Even when the unit’s screen aspect ratio displays 4:3, the color bars are generated as 16:9. To output the edge crop (4:3) in HDV format, select [TYPE 1].</li> <li>• Color bars on the unit are generated in HDV (1080i) resolution. When a resolution other than HDV (1080i) is output, the color bars are down converted and output. The transition edges between the color bars are distorted.</li> <li>• You cannot change the current setting during recording.</li> </ul>
	DV BARS	<p>Selects the aspect ratio of color bars set in [BARS TYPE] (DVCAM/DV (SP) format only).</p> <p><b>[16:9]</b>: Sets the aspect ratio of color bars to 16:9.  <b>[4:3]</b>: Sets the aspect ratio of color bars to 4:3.</p> <p><b>Note</b>  You cannot change the current setting during recording.</p>
	EE/PB SEL	<p>Sets the stop, fast-forward and rewind modes.</p> <p><b>[EE]</b>: Outputs EE pictures and EE sounds.  <b>[PB]</b>: Mutes the image and sound.</p> <p><b>Note</b>  Even [PB] is selected, when you press REC button: <ul style="list-style-type: none"> <li>– EE pictures and EE sounds are output.</li> <li>– When [HDV/DV IN TC] in [TC/UB SET] menu is set to [EXTERNAL], and INPUT SELECT switch is set to HDV/DV, the time code of the other device connected to <b>i</b> HDV/DV jack is displayed on Data display screen.</li> </ul> </p>
	480i LEVEL	<p>Selects the component output level of luminance and chrominance from either BETACAM or SMPTE signals when the component output is 480i.</p> <p><b>[SMPTE]</b>: Sets COMPONENT OUT jacks to SMPTE level.  <b>[BETACAM]</b>: Sets COMPONENT OUT jacks to BETACAM level.</p> <p><b>Note</b>  For details on COMPONENT OUT jacks specifications, see page 75.</p>





## DISPLAY SET menu

Icon/Menu	Submenu	Setting
 DISPLAY SET	DATA CODE <i>(page 28)</i>	Selects whether or not to display the data codes on the analog video output. <b>OFF</b> : Does not display the data codes. <b>DATE</b> : Displays the date and time when recorded. <b>CAMERA DATA</b> : Displays the camera data.
	LETTER SIZE	Selects the letter size of the menu at the cursor. <b>NORMAL</b> : Normal size <b>2×</b> : Double height size
	DATE DISPLAY	Selects the date display in the search screen, the data code display. <b>Y/M/D</b> : Displays YY/MM/DD (year/month/day). <b>M/D/Y</b> : Displays MM/DD/YY (month/day/year). <b>D/M/Y</b> : Displays DD/MM/YY (day/month/year).
	TIME DISPLAY	Selects the time display in the search screen, the data code display. <b>12H</b> : Displays 12-hour time. (If 60i system is the factory setting.) <b>24H</b> : Displays 24-hour time. (If 50i system is the factory setting.)
	 REMAINING <i>(page 18)</i>	<b>AUTO</b> : The remaining tape time is displayed for 8 seconds under the following conditions: – If the remaining tape time is determined when you turn on power while a cassette is loaded in the unit. – When you press PLAY button. Always displays under the following conditions: – Fast forward, rewind – Fast forward during playback, rewind during playback <b>ON</b> : Always displays the remaining tape time.

# Operating the Menus

## AUDIO SET menu

Icon/Menu	Submenu	Setting
 AUDIO SET	AUDIO MODE (page 35)	Selects the audio mode. <b>FS32K</b> : Switches the audio mode to 4-channel mode (12-bit mode). <b>FS48K</b> : Switches the audio mode to 2-channel mode (16-bit mode). (This setting records the sound in all audio ranges, providing a high-quality sound recording.)  <b>Notes</b> <ul style="list-style-type: none"> <li>• When signals are input from  HDV/DV jack, the audio mode of the signals to be recorded is the same as that of the input signals.</li> <li>• Recording performs automatically in [FS48K] mode in HDV format.</li> <li>• You cannot change this setting during recording.</li> <li>• Noise may occur at the instant you switch the audio mode.</li> <li>• To dub audio using an audio dubbing device, select [FS32K].</li> </ul>
	AUDIO AGC	Selects whether to adjust the [AUDIO REC LV] automatically or not. <b>ON</b> : Adjusts the audio recording level automatically. <b>OFF</b> : Adjusts the audio recording level manually. (Set the audio recording level with [AUDIO REC LV] (pages 35, 50).)  <b>Note</b> Even this switch is set to [ON], the setting is not effective against the volume which exceeds the dynamic range of the input amplifier. For details on the available volume levels, see the “Specifications” of the unit (page 74).
	AUDIO REC LV	Adjusts the audio recording level for analog audio input (CH-1 and 2) while recording. <b>-6 db</b> : Decreases 6 dB from the original audio input level. <b>0 db</b> : Leaves the original audio input level. <b>+6 db</b> : Increases 6 dB from the original audio input level.  <b>Notes</b> <ul style="list-style-type: none"> <li>• This setting is available only when [AUDIO AGC] is set to [OFF].</li> <li>• If the audio level exceeds 0 dB at maximum volume, sound distortion occurs.</li> <li>• For details on the maximum audio recording level input, see “Specifications” on page 74.</li> </ul>
	AUDIO MIX	Selects the audio to be output from AUDIO jacks during the 4-channel mode. <b>CH1, CH2</b> : Outputs only channels 1 and 2 audio. <b>MIX</b> : Outputs the synthesized audio of channels 1 and 3, and channels 2 and 4. (Each signal level will be 50% (-6 db) of the original audio level.) <b>CH3, CH4</b> : Outputs only channels 3 and 4 audio only.  <b>Notes</b> <ul style="list-style-type: none"> <li>• You cannot set this menu for a tape recorded using the [FS48K] audio mode of [AUDIO MODE] menu.</li> <li>• You cannot set this menu during HDV recording/playback.</li> <li>• The audio level meter displays the audio level of the current setting in this menu.</li> </ul>

Icon/Menu	Submenu	Setting
 AUDIO SET	AUDIO LOCK	<p><b>UNLOCK MODE</b>: Records the sampling clocks of audio and video independently. This mode applies to a consumer DV tape.</p> <p><b>LOCK MODE</b>: Synchronizes the sampling clocks of the audio and video for recording. This setting is effective for digital processing and performs a clean splice during the audio editing process.</p> <p><b>Notes</b></p> <ul style="list-style-type: none"> <li>• You can set this menu when recording in DV format (SP mode) only.</li> <li>• When recording in HDV or DVCAM format, the menu is set to [LOCK MODE].</li> <li>• During the i.LINK input, the same setting as that of an input signal is selected regardless of this setting.</li> </ul>
	JOG AUDIO (page 30)	<p>Selects either to turn the sound output on or off when the tape is played at a speed other than normal (DVCAM/DV (SP) format only).</p> <p><b>OFF</b>: Does not output the sound when playing a tape at a speed other than normal.</p> <p><b>ON</b>: Outputs the sound when playing a tape at a speed other than normal.</p> <p><b>Notes</b></p> <ul style="list-style-type: none"> <li>• Even if you have set this item to ON, the sound may not be output or may be interrupted depending on the recording format or tape conditions.</li> <li>• The unit cannot output sound with a tape recorded in HDV format at a speed other than normal.</li> </ul>

## VTR SET menu





Icon/Menu	Submenu	Setting
 VTR SET	AUTO REPEAT (page 31)	<p>Selects whether to playback with automatic repeat or not.</p> <p><b>OFF</b>: Disables playback with AUTO REPEAT.</p> <p><b>ON</b>: Enables playback with AUTO REPEAT.</p>
	AUTO INDEX (page 36)	<p>Selects whether or not to mark an index signal automatically when the unit in the stop mode starts recording.</p> <p><b>ON</b>: Marks an index signal at the beginning of the recording.</p> <p><b>OFF</b>: Does not mark an index signal at the beginning of the recording.</p>
	STILL PICT	<p>Selects the image displayed in the still mode (DVCAM/DV (SP) format only).</p> <p><b>AUTO</b>: Displays an optimized image according to the movement in the image.</p> <p><b>FRAME</b>: Displays a frame image.</p> <p><b>FIELD</b>: Displays a field image.</p> <p><b>Notes</b></p> <ul style="list-style-type: none"> <li>• If you select [FIELD], the image of 2nd field is displayed.</li> <li>• When a tape has been recorded in HDV format, a filed image is always displayed.</li> </ul>
	FF/REW SPEED (page 10)	<p>Selects the tape transport mode in fast-forward and rewind.</p> <p><b>FF/REW</b>: Fast-forwards or rewinds the tape at maximum speed without displaying the picture.</p> <p><b>SHUTTLEMAX</b>: Fast-forwards or rewinds the tape at maximum speed while displaying the picture.</p> <p>DVCAM</p> <p>NTSC: Approx. 14 times of normal speed</p> <p>PAL: Approx. 17 times of normal speed</p> <p>HDV/DV(SP)</p> <p>Approx. 24 times of normal speed</p>

(Continued)

# Operating the Menus

Icon/Menu	Submenu	Setting
 VTR SET	STILL TIME	Selects the time to switch to the tape protection mode from the still mode. <b>30 sec</b> : 30 seconds <b>1 min</b> : 1 minute <b>2 min</b> : 2 minutes <b>3 min</b> : 3 minutes <b>Notes</b> <ul style="list-style-type: none"> <li>• If the unit is left in playback pause mode for a long time, the tape or the video heads may be damaged or the video heads may become clogged. Select the shortest time possible. Particularly, when using a Mini-DV cassette that is longer than 60 minutes, select [30 SEC] or [1 MIN].</li> <li>• When the setting is changed, the first tape protection mode change uses the time setting from before the settings were changed. From the second tape protection mode change, the new time setting is used.</li> </ul>
	FROM STILL	Selects the tape protection mode to change the mode after the time set in [STILL TIME] is past <b>STOP</b> : Stops the tape. <b>STEP FORWARD</b> : Forwards one frame. <b>Note</b> If you play a tape recorded in HDV format with [STEP FORWARD] selected, the tape advances a few frames forward.
	FROM REC P	Selects the tape protection mode which the unit changes after the recording has been paused for more than 3 minutes. <b>STOP</b> : Stops the tape. <b>REC PAUSE</b> : Maintains the recording pause mode. <b>Note</b> When the recording pause mode continues for a long time after you select [REC PAUSE], the tape may be damaged or the video heads may be damaged or clogged. If there is no other reason to do this, select [STOP]. Particularly when you use a Mini-DV cassette that is longer than 60 minutes, select [STOP].

## TC/UB SET menu

Icon/Menu	Submenu	Setting
 TC/UB SET	HDV/DV IN TC	Selects whether to record internal time code or external time code while the unit records the signals input from  HDV/DV jack. <b>INTERNAL</b> : Records the time code generated by the internal time code generator. (If no time code is recorded on the tape, the unit records time code from 00:00:00:00. If there is time code already recorded on the tape, the unit records continuous time code from this point.) <b>EXTERNAL</b> : Records the time code with video and audio signals input from  HDV/DV jack. <b>Notes</b> <ul style="list-style-type: none"> <li>• When this item is set to [EXTERNAL], INPUT SELECT switch on the front panel is set to HDV/DV, and no signal is input from  HDV/DV jack, if you start recording, bars (—:—:—:—) are recorded as time code. At the point that inputting of a signal begins, the time code of that signal will be recorded.</li> <li>• If you set this item to [EXTERNAL] and the external time code input is discontinuous or does not advance correctly, recording or displaying the time code on the unit may not be done correctly. If there is a discontinuous time code on your recorded tape, you may not be able to edit or search correctly, depending on the device used to edit.</li> </ul>

Icon/Menu	Submenu	Setting
00:00 TC/UB SET	TC FORMAT	<p>Selects the recording mode of the time code when 60i is selected.</p> <p><b>AUTO</b> : Automatically sets the mode in accordance with the mode already set on a cassette tape. (If nothing is recorded on the tape, the non-drop frame mode is set. If the unit cannot correctly read the frame mode on the tape, it will use the frame mode that was set in the last position on the tape that the unit can read correctly. If you remove the cassette, the mode of the last position that the unit was able to read correctly is cleared and the non-drop frame mode is set when recording is restarted from the same position.)</p> <p><b>DF</b> : Selects the drop frame mode.</p> <p><b>NDF</b> : Selects the non-drop frame mode.</p> <p><b>Note</b> When [60i/50i SEL] is set to [50i], the unit operates as a 50i specification model. Therefore, the internal time code is set to the non-drop frame mode. Even if 60i signals are input to , HDV/DV jack when [60i/50i SEL] is set to [50i], the time code generated by the unit is in the non-drop frame mode regardless of [TC FORMAT] setting. To set the time code in the drop frame mode, set [60i/50i SEL] to [60i]. As a result, [TC FORMAT] setting will return to the status before [60i/50i SEL] was set to [50i].</p>
	TC RESET	<p>Reset the time code value to 00:00:00:00.</p> <p><b>NO</b> : Does not reset the time code value.</p> <p><b>YES</b> : Resets the time code value.</p> <p><b>Note</b> This setting is available only when the unit in REC or REC PAUSE mode. Also, when INPUT SELECT switch is set to HDV/DV and [HDV/DV IN TC] is set to [EXTERNAL], this setting will not be affected and the time code will not be reset.</p>

## OTHERS menu

Icon/Menu	Submenu	Setting
 OTHERS	LANGUAGE	You can select the desired language on Data display screen. You can choose Simplified English if your native language is not available among the options.
	COMMANDER (page 16)	<p>Selects the control device.</p> <p><b>WIRELESS</b> : Enables the control of Remote Commander.</p> <p><b>CONTROL S</b> : Enables the control of the remote control unit DSRM-10 (not supplied) connected to CONTROL S IN jack. (Remote Commander is disabled.)</p> <p><b>Notes</b></p> <ul style="list-style-type: none"> <li>The unit accepts signals from any Sony Remote Commander whose command mode is set to VTR4, not only the supplied one. To disable the control from any Remote Commander, set this item to [CONTROL S].</li> <li>You can also use the DSRM-20 (no longer manufactured: not supplied).</li> </ul>

(Continued)

# Operating the Menus

Icon/Menu	Submenu	Setting
OTHERS	PB YNR	<p>Selects the noise reduction level for the luminance signals when a tape is played.</p> <p><b>OFF</b> : No noise reduction  <b>LOW</b> : Low noise reduction  <b>HIGH</b> : High noise reduction</p> <p><b>Notes</b></p> <ul style="list-style-type: none"> <li>• When you use noise reduction, there may be an afterimage depending on the condition of the picture.</li> <li>• Noise reduction is also available with pictures output from  HDV/DV jack. Use caution when dubbing and editing a picture in HDV/DV.</li> </ul>
	PB CNR	<p>Selects the noise reduction level for the chrominance signals when a tape is played.</p> <p><b>OFF</b> : No noise reduction  <b>LOW</b> : Low noise reduction  <b>HIGH</b> : High noise reduction</p> <p><b>Notes</b></p> <ul style="list-style-type: none"> <li>• When you use noise reduction, there may be an afterimage depending on the condition of the picture.</li> <li>• Noise reduction is also available with pictures output from  HDV/DV jack. Use caution when dubbing and editing a picture in HDV/DV.</li> </ul>
	CLOCK SET	<p><b>1</b> Press  buttons to adjust the number, then press  buttons to set the month, day, hour, and minute.</p> <p><b>2</b> Press EXEC button to execute.</p> <p><b>Notes</b></p> <ul style="list-style-type: none"> <li>• 12:00 AM stands for midnight and 12:00PM stands for noon when [TIME DISPLAY] is set to [12H].</li> <li>• If you do not use the unit for 3 months or more, the built-in rechargeable battery will become completely discharged, and the settings of the day and the time may be cleared from the memory. In this case, charge the built-in rechargeable battery and set the clock again (<i>page 67</i>).</li> </ul>
	HOURS METER	<p>Displays the accumulated time counts (by the digital hours meter) in units of 10 hours or 10 counts.</p> <p><b>OPERATION</b> : Power on duration  <b>DRUM RUN</b> : Drum rotation duration  <b>TAPE RUN</b> : Tape run duration  <b>THREADING</b> : Tape unthreading count</p>
	AC ON MODE	<p>Switches the state into which the unit goes when the unit is connected to the AC outlet.</p> <p><b>STANDBY</b> : Makes the unit go into the standby mode.  <b>ON</b> : Turns the unit on.</p>

Icon/Menu	Submenu	Setting
OTHERS	60i/50i SEL <i>(page 34)</i>	<p>Switches to the 1080/60i (NTSC) or the 1080/50i (PAL).</p> <p>1 Press <math>\uparrow/\downarrow</math> buttons to select [YES], then press EXEC button.</p> <div data-bbox="847 363 1121 517" style="border: 1px solid black; padding: 5px; margin: 10px auto; width: fit-content;"> <p style="text-align: center;">60i/50i SEL</p> <p style="text-align: center;">Change to 50i? Reboots after change.</p> <hr style="width: 80%; margin: 0 auto;"/> <p style="text-align: center;">YES NO</p> </div> <p>2 Press <math>\uparrow/\downarrow</math> buttons to select [YES] again, then press EXEC button.</p>
	INITIALIZE	<p>Resets the menu to factory settings except CLOCK SET.</p> <p>1 Press <math>\uparrow/\downarrow</math> buttons to select [YES], then press EXEC button.</p> <div data-bbox="847 672 1121 825" style="border: 1px solid black; padding: 5px; margin: 10px auto; width: fit-content;"> <p style="text-align: center;">INITIALIZE</p> <p style="text-align: center;">Reset all settings except "CLOCK SET" to defaults.</p> <hr style="width: 80%; margin: 0 auto;"/> <p style="text-align: center;">YES NO</p> </div> <p>2 Press <math>\uparrow/\downarrow</math> buttons to select [YES] again, then press EXEC button.</p>

# Maintenance

## Troubleshooting

Please check the following before contacting your Sony dealer.

### General Operation Troubles



Symptom	Cause/Remedy
A menu item is not available.	<ul style="list-style-type: none"> <li>• There are menus that cannot be used depending on the setting in [IN/OUT REC] menu. → Change [IN/OUT REC] menu settings (<i>page 46</i>).</li> <li>• Some menu items are only available in EE mode or playback mode. → Set the unit to EE mode or playback mode.</li> <li>• Some menu items are only available when the tape is inactive.</li> <li>• There are some menus you cannot use without setting the clock.</li> <li>• Some menu items are not available when REC/SAVE switch on the cassette inside the unit has been set to SAVE. → Set the switch to REC.</li> </ul>
Some menu item settings change accidentally.	<ul style="list-style-type: none"> <li>• You have pulled out the power cord during a menu operation. → Adjust the menu again. To prevent this incident recurring, do not pull out the plug while adjusting the menu.</li> </ul>
The unit operates by itself.	<ul style="list-style-type: none"> <li>• [COMMANDER] in [OTHERS] menu is set to [WIRELESS] and a Sony Remote Commander whose command mode is set to VTR4 is operated near the unit. → Set [COMMANDER] to [CONTROL S].</li> </ul>
The supplied wireless Remote Commander does not work.	<ul style="list-style-type: none"> <li>→ Set [COMMANDER] in [OTHERS] menu to [WIRELESS].</li> </ul>
Even though the settings on the unit are correct, you cannot make the unit record using the Remote Control Unit DSRM-10 (not supplied).	<ul style="list-style-type: none"> <li>• On the Remote Control Unit DSRM-10, press PLAY button while holding REC button down.</li> </ul>
Whenever you connect the unit to an AC outlet or the AC adaptor, the unit turns on automatically.	<ul style="list-style-type: none"> <li>• [AC ON MODE] in [OTHERS] menu is set to [ON]. → Set [AC ON MODE] to [STANDBY].</li> <li>• There is a cassette inside the unit and [AUTO REPEAT] in [VTR SET] menu is set to [ON]. → Set [AUTO REPEAT] to [OFF].</li> </ul>



## Power sources



Symptom	Cause/Remedy
The power cannot be turned on.	<ul style="list-style-type: none"> <li>The power cord of the AC adaptor is disconnected. → Connect the AC power cord.</li> </ul>
The unit does not operate even if the power has been turned on.	<ul style="list-style-type: none"> <li>Moisture condensation has occurred (<i>page 66</i>).</li> <li>The cassette is not inserted straight. → Eject and reinsert it straight.</li> <li>→ Disconnect the power supply and then reconnect it after about 1 minute. If the unit does not operate even after you reconnect the power, use a sharp-tipped ballpoint pen or similar tool to press RESET button. When you press RESET button, all settings including the date and time and [60i/50i SEL] will be initialized.</li> </ul>
The unit does not operate properly when the AC adaptor is used.	→ Turn off the power and remove the power cord from the AC outlet and then reconnect the power cord.

## Cassette tapes

Symptom	Cause/Remedy
The cassette cannot be inserted.	<ul style="list-style-type: none"> <li>There is moisture condensation on the head drum (<i>page 66</i>). → With the unit powered on, wait more than one hour.</li> <li>The cassette is not inserted straight. → Eject and reinsert it straight.</li> <li>Another cassette has been loaded already. → Remove the cassette and insert the one you want to load.</li> </ul>
It takes time to eject the cassette.	<ul style="list-style-type: none"> <li>This is not a malfunction. → The unit ejects the cassette slowly to protect the tape. While the cassette is being ejected,  (cassette) indicator blinks.</li> </ul>
A cassette tape cannot be removed.	→ Check whether the power supply is connected properly.
The cassette tape is not ejected when you press EJECT button.	<ul style="list-style-type: none"> <li>Moisture condensation has occurred in the unit (<i>page 66</i>).</li> </ul>
The cassette memory data and title are not displayed when using a cassette tape with the cassette memory function.	<ul style="list-style-type: none"> <li>The unit does not support the cassette memory function and therefore such data is not displayed.</li> </ul>
The remaining tape time is not displayed.	→ To always display the remaining tape time, set  [REMAINING] in [DISPLAY SET] menu to [ON].

# Troubleshooting

## Output/Playback

Symptom	Cause/Remedy
Cannot playback.	→ If a tape has reached its end, rewind the tape.
Cannot playback in reverse at various speeds.	• The unit cannot play back a tape recorded in HDV format in the reverse direction at various speeds ( <i>page 29</i> ).
Horizontal lines are displayed on an image. An image has block noise. An image is blurred or not displayed.	<ul style="list-style-type: none"> <li>• The video heads are dirty. → Clean the video heads using the supplied cleaning cassette.</li> <li>• A damaged tape is loaded. → Remove the cassette and insert another one.</li> <li>• You have tried to make the unit play back a tape recorded in LP mode of DV format. → The unit can play back only tapes recorded in HDV, DVCAM or DV (SP) format. A tape recorded in LP mode of DV format cannot be played back on the unit.</li> </ul>
No picture is output from  , HDV/DV jack.	<ul style="list-style-type: none"> <li>→ Reconnect the i.LINK cable (not supplied).</li> <li>• INPUT SELECT switch is set to a position other than HDV/DV. → Set the switch to HDV/DV.</li> <li>→ Set [HDV/DV SEL] in [IN/OUT REC] menu correctly.</li> </ul>
The audio breaks up.	<ul style="list-style-type: none"> <li>• A damaged tape is loaded. → Remove the cassette and insert another one.</li> <li>• The video heads are dirty. → Clean the video heads using the supplied cleaning cassette.</li> <li>• You have tried to make the unit play back a tape recorded in LP mode of DV format. → The unit can play back only tapes recorded in HDV, DVCAM, or DV (SP) format. A tape recorded in LP mode of DV format cannot be played back on the unit.</li> </ul>
Cannot perform a date search and index search.	• There is a portion with no recording at the beginning or in the middle of a tape. This is not a malfunction.
The time code is not reset to "00:00:00:00" after rewinding a tape to the recording starting point.	→ The time code is not displayed correctly at the starting point of recording. This condition, however, is not a malfunction. When you restart playback, the time code and images are displayed correctly from the starting point.
"-- -- --" appears ( <i>page 28</i> ).	<ul style="list-style-type: none"> <li>• The tape has been played back without setting the date and time. → Set the date and time.</li> <li>• The tape portion being played back has no recording.</li> <li>• If there is a scratch or noise on the tape, the data code cannot be read.</li> </ul>
Although the component video cable is connected properly to a television set or monitor to play back a tape, no image or audio is output.	<ul style="list-style-type: none"> <li>→ Use the correct setting for [COMPONENT] of [VIDEO OUT] in [IN/OUT REC] menu in accordance with the equipment to be connected.</li> <li>• No audio is output from COMPONENT OUT jacks. → Connect also an audio cable.</li> </ul>
When you connect the unit to a 4:3 television set, the displayed image appears flattened.	<ul style="list-style-type: none"> <li>→ When you output from COMPONENT OUT jacks, set [COMPONENT] and [DOWN CONVERT] of [VIDEO OUT] in [IN/OUT REC] menu correctly before play back.</li> <li>When you output from , HDV/DV jack, set [HDV → DV CONV] and [DOWN CONVERT] of [i.LINK SET] in [IN/OUT REC] menu correctly before play back.</li> <li>When you output from S VIDEO jack and VIDEO jack, set [DOWN CONVERT] of [VIDEO OUT] in [IN/OUT REC] menu correctly before playback.</li> <li>→ DVCAM/DV tape images recorded in the wide mode are not displayed properly. Use a widescreen-compatible monitor.</li> </ul>

Symptom	Cause/Remedy
Even though [HDV/DV IN TC] in [TC/UB SET] menu is set to [EXTERNAL], the time code of the input i.LINK signal is not recorded.	<ul style="list-style-type: none"> <li>• i.LINK signal output from the digital non-linear editing controller does not include a time code. → Confirm that the editing software you are using is capable of outputting a time code.</li> <li>• INPUT SELECT switch is not set to HDV/DV. → Set INPUT SELECT switch to HDV/DV.</li> </ul>
After playing at 1/10 of normal speed in forward or reverse for more than 1 minute, normal playback forward starts.	→ To protect a tape, the unit is set to start normal playback after playing at 1/10 of normal speed in forward or reverse for more than 1 minute. Play back the tape at 1/3 of normal speed in forward or reverse.
Playback pause mode is released and the unit goes into the stop mode.	→ To protect the tape, the unit is set to go into the stop mode after the playback pause mode continues for a certain period. Set [FROM STILL] in [VTR SET] menu to [STEP FORWARD]. If you do so, the tape will forward for time of interval set in [STILL TIME].
Playback pause mode is released and the tape forwards by one frame for each preset time interval.	→ To protect the tape, the unit is set to forward the tape by one frame after the playback pause mode continues for a certain period. Set [FROM STILL] in [VTR SET] menu to [STOP]. If you do so, the unit will go into the stop mode after the playback pause mode continues for the interval set in [STILL TIME].
The pause mode of recording is released automatically.	→ To protect the tape and the video heads, the unit goes into the stop mode after the pause mode of recording, audio dubbing, or duplicating continues for more than about 3 minutes. To avoid the stop mode, set [FROM REC P] in [VTR SET] menu to [REC PAUSE] (page 52).
When the tape is rewound to its beginning, the playback automatically starts.	<ul style="list-style-type: none"> <li>• [AUTO REPEAT] in [VTR SET] menu is set to [ON]. → Set [AUTO REPEAT] to [OFF].</li> <li>• You pressed PLAY button while holding REW button down. → If you do this, the unit rewinds the tape to its beginning and begins playback (page 11).</li> </ul>
During playback, the unit starts rewinding suddenly.	<ul style="list-style-type: none"> <li>• [AUTO REPEAT] in [VTR SET] menu is set to [ON]. → When [AUTO REPEAT] is set to [ON], the unit starts rewinding at the moment when a signal for index search or a blank portion is detected. Set [AUTO REPEAT] to [OFF].</li> </ul>
When the tape reaches its end, rewinding starts automatically.	<ul style="list-style-type: none"> <li>• [AUTO REPEAT] in [VTR SET] menu is set to [ON]. → When [AUTO REPEAT] is set to [ON], the unit starts rewinding at the moment when the end of the tape is detected. Set [AUTO REPEAT] to [OFF].</li> </ul>
No sound or undesired sound is output from AUDIO OUT jacks.	<ul style="list-style-type: none"> <li>• When the audio mode is 32 kHz (4-channel), you can select the audio channel. Set [AUDIO MIX] in [AUDIO SET] menu according to the desired channel.</li> </ul>
The unit starts recording/playback by itself without commands.	<ul style="list-style-type: none"> <li>• [AUTO REPEAT] in [VTR SET] menu is set to [ON]. → Set [AUTO REPEAT] to [OFF].</li> <li>• When [COMMANDER] in [OTHERS] menu is set to [WIRELESS], the unit responds to signals from Remote Commander. → Set [COMMANDER] to [CONTROL S].</li> </ul>

(Continued)

# Troubleshooting

Symptom	Cause/Remedy
The unit does not function as part of a digital non-linear editing system.	<ul style="list-style-type: none"> <li>• INPUT SELECT switch is set to a setting other than HDV/DV. → Set it to HDV/DV.</li> <li>• The editing controller or the editing software is not compatible with the unit. → Refer to the instruction manuals of the controller or the software and consult their manufacturers.</li> </ul>
Although the i.LINK cable is connected, the image from an external equipment is not displayed.	<ul style="list-style-type: none"> <li>• Disconnect and then reconnect the i.LINK cable correctly.</li> <li>• INPUT SELECT switch is set to a setting other than HDV/DV. → Set it to HDV/DV.</li> </ul>
No image is displayed even though the video cable is connected correctly.	<ul style="list-style-type: none"> <li>• There are output restrictions for some [COMPONENT] settings of [VIDEO OUT] in [IN/OUT REC] menu. For details of [COMPONENT], see pages 14, 47.</li> <li>• INPUT SELECT switch setting does not match the cable connected to the unit. → Set INPUT SELECT switch to S VIDEO or VIDEO to match the cable connection.</li> </ul>
The image loses color or is distorted when you play back the tape on a television set or monitor connected to the unit.	<ul style="list-style-type: none"> <li>→ Connect the unit to a television set or monitor that is compatible with its [60i/50i SEL] format.</li> <li>→ Set [60i/50i SEL] in [OTHERS] menu, according to the signal-format (page 55).</li> </ul>
2/2-ST is displayed on the screen.	<ul style="list-style-type: none"> <li>• This icon is displayed when you playback a tape recorded with 4-channel microphone recording on another device. This unit does not support 4-channel microphone recording. (The icon is displayed when you play back a tape recorded with 4-channel microphone in DVCAM or DV (SP) format. However, it is not displayed during playback of a tape recorded with 4-channel microphone in HDV format.)</li> </ul>





## Recording

Symptom	Cause/Remedy
No picture is output via  HDV/DV jack.	<ul style="list-style-type: none"> <li>→ Reconnect the i.LINK cable (not supplied).</li> <li>• INPUT SELECT switch is set to a position other than HDV/DV.               <ul style="list-style-type: none"> <li>→ Set the switch to HDV/DV.</li> </ul> </li> <li>→ Set [HDV/DV SEL] in [IN/OUT REC] menu correctly.</li> </ul>
About the audio level setting: <ul style="list-style-type: none"> <li>• You do not know how to adjust the input level.</li> <li>• The recorded level is too low.</li> <li>• The recorded sound is distorted.</li> </ul>	Confirm the level of the sound output from the player by referring to the player's instruction manual. If you are not clear about the player's output level, try the following procedures. <ul style="list-style-type: none"> <li>• Set [AUDIO AGC] in [AUDIO SET] menu to [OFF], set [AUDIO REC LV] to [0 dB], and play back the tape which you intend to use for playback. When the playback audio level is at its maximum, if the audio levels meters exceed 0 dB, set [AUDIO REC LV] to [-6 dB]. When the volume is too low, set [AUDIO REC LV] to [+6 dB]. The recorded sound at the portion where the meters exceed 0 dB will be distorted.</li> </ul> For details of the acceptable maximum input level, <i>see page 50</i> .
No sound or undesired sound is output from AUDIO jacks in OUTPUT.	<ul style="list-style-type: none"> <li>→ When the audio mode is 32 kHz (4-channel), set [AUDIO MIX] in [AUDIO SET] menu to [CH1, CH2]. When the audio mode is 32 kHz (4-channel) on the unit, audio is recorded in channel 1/2.</li> </ul>
If an i.LINK cable is connected when you editing, the monitor does not display any image.	<ul style="list-style-type: none"> <li>→ Use the correct setting for [HDV/DV SEL] in [IN/OUT REC] menu in accordance with the equipment to be connected.</li> </ul>
EE sound is not output.	<ul style="list-style-type: none"> <li>→ If the audio mode is set to 32 kHz (4-channel), Set [AUDIO MIX] to [CH1, CH2] or [MIX].</li> </ul>
EE picture and EE sound are not output.	<ul style="list-style-type: none"> <li>• [EE/PB SEL] in [IN/OUT REC] menu is set to [PB].               <ul style="list-style-type: none"> <li>→ Set [EE/PB SEL] to [EE].</li> </ul> </li> <li>• The setting of INPUT SELECT switch does not match the signal input.               <ul style="list-style-type: none"> <li>→ Set the switch according to the signal input.</li> </ul> </li> <li>• With an analog connection, the current setting of [60i/50i SEL] in [OTHERS] menu is not appropriate.               <ul style="list-style-type: none"> <li>→ Set it to the appropriate position for the device you are using.</li> </ul> </li> </ul>

# Warning indicators and messages

## Self-diagnosis display/Warning Indicators







The following alarm indicators may appear on an external monitor. For further information about each symptom and recovery method, see the relevant page indicated in the parentheses.

Message/Alarm Indicator	Cause/Corrective Action
C:□□:□□/E: □□:□□ (Self-diagnosis display)	<p>If an error still recurs after you retry the corrective actions several times, contact Sony Customer Service or your place of purchase.</p> <p><b>C:21:□□</b> → Condensation has occurred. Remove the cassette and insert it again after approximately 1 hour (<i>page 66</i>).</p> <p><b>C:22:□□</b> → The video head is dirty. Use a cleaning cassette to clean the head (<i>page 64</i>).</p> <p><b>C:31:□□/C:32:□□</b> → Symptoms other than the above are occurring. Insert a cassette again and retry the operation. Do not take this action, however, if there is negligible condensation in the unit (<i>page 66</i>). → Unplug the power cord, plug it in again, and then retry the operation. → Replace the tape.</p>
 (Moisture condensation warning)*	→ Remove the cassette, unplug the power cord, and leave the unit for approximately 1 hour with Cassette Lid left open ( <i>page 66</i> ).
 (Warning indicator pertaining to the tape)	<p><b>The icon blinks slowly.</b></p> <ul style="list-style-type: none"> <li>• The remaining tape time is less than 5 minutes.</li> </ul>
 (Eject cassette warning)*	<p><b>The icon blinks rapidly.</b></p> <ul style="list-style-type: none"> <li>• Condensation has occurred (<i>page 66</i>).</li> <li>• The self-diagnostics message is displayed (<i>page 62</i>).</li> </ul>

\* CAUTION indicator will blink when an alarm indicator or message is displayed (*page 11*).

## Alarm Messages

The following alarm messages appear with the alarm indicators. Take appropriate action according to the displayed message.

Item	Message	Cause/Corrective Action
Moisture condensation	 ▲ Moisture condensation. Eject the cassette.	→ See page 66 for details.
	 Moisture condensation. Turn off for 1H.	→ See page 66 for details.
Cassette/Tape	 Insert a cassette.	→ See page 21.
	▲ Reinsert the cassette.	• Check for damage on a tape or other irregularities.
	 ▲ The tape is locked -check the tab.	→ See page 20.
	 The tape has reached the end.	—
Others	Cannot record due to copyright protection.	—
	Change to correct tape format.	• This is an unsupported format and cannot be played back.
	No output image in “HDV/DV SEL”. Change format.	Stop playback or signal input, or change [HDV/DV SEL] setting (page 46).
	 Dirty video head. Use a cleaning cassette.	→ See page 64.
	Unplug power cable.	—
	Reinsert the cassette.	—
	Invalid input signal.	The signal that has been input to the unit is invalid. Check the input signal.
	Power voltage error.	—

## Notes on the Videocassette Recorder

### Do not use the unit in a place subject to direct sunlight or heat sources

If you do, its cabinet, mechanical parts, etc., may be damaged.

### Do not place the unit in humid places

Do not place the unit in places where they may be exposed to water-splash or to humidity. Do not place water-filled containers or vases on the unit. Doing so may cause the unit malfunction.

### Do not use the unit in an extremely hot place

If the unit is left in a car parked with the windows closed (especially in summer), its cabinet, mechanical parts, etc., may be damaged or it may not work correctly.

### If the unit is brought directly from a cold to a warm location

Moisture may condense inside the unit and cause damage to the video heads and tape. If you use the unit in a place subject to direct cold currents from an air conditioner, moisture may also condense inside the unit.

### Do not place a heavy object on the unit

The cabinet, mechanical parts, etc., may be damaged, or the unit may not work correctly.

### Do not handle the unit roughly

Avoid rough handling or mechanical shock to the unit.

### To avoid damaging the cabinet's finish

Plastic is often used for the surface finishing of the unit. Do not spray a volatile solvent such as an insecticide toward the cabinet or place rubber or vinyl products on the cabinet for a long time. If you do, the finish of the cabinet may be damaged or the coating may come off.

### Do not clean the cabinet with thinner or benzine

The cabinet may be damaged or its coating may come off. When you use a chemical-impregnated cloth, use it according to its directions.

### Clean the cabinet with a soft dry cloth

When the cabinet is very dirty, clean it with a soft dry cloth lightly moistened with a mild detergent solution and finish it with a dry cloth.

### Do not put magnetic objects close to the unit

Magnetic fields may damage the recording.

### To prevent electromagnetic interference caused by radio communication equipment such as cellular phones, transceivers, etc.

The use of the radio communication equipment such as cellular phones or transceivers near the unit may cause a malfunction and can affect the audio/video signals. Cellular phones or transceivers near the unit should be switched off.

### Do not use the unit in an area exposed to radiation

A malfunction may occur.

### Checking the video heads every 1000 hours

A VCR is a high-precision piece of equipment that records and plays back the picture recorded on a magnetic tape. In particular, the video heads and other mechanical parts may become dirty or worn. To maintain a clean picture, we recommend maintenance every 1000 hours, even though the conditions of use may differ depending on temperature, humidity, dust, etc.

### About connecting other equipment

When you connect the unit to another equipment or a computer using an i.LINK cable, confirm the direction of the jack. If you forcibly insert the jack, the terminal may be damaged or cause the unit to malfunction.

## Cleaning of the Video Heads

With clogged video heads, the unit cannot record properly. Clean the video heads to prevent noise on the recorded picture or audio. For cleaning, use the supplied cleaning cassette.

### Before recording an important event

The unit cannot record properly with the clogged video heads. To ensure normal recording and clear pictures and sound, clean the video heads before recording an important event.



### Every 50 hours



If you repeat the tape transport operation, the video heads will become dirty and coated with fine dirt or dust. Clean the heads every 50 hours.

### After using a tape prone to clog the heads

After using such a tape causes the symptoms illustrated below, clean the heads.

### When the symptoms caused by clogged video heads appear

Even if you clean the heads periodically, clogging of the heads may occur anyway. Clean the heads when:

- mosaic-pattern noise appears on the playback picture.
- the playback picture freezes.
- a part of the playback picture does not move.
- playback pictures do not appear.
- playback audio is interrupted.
- “  Dirty video head. Use a cleaning cassette.” will appear during recording.

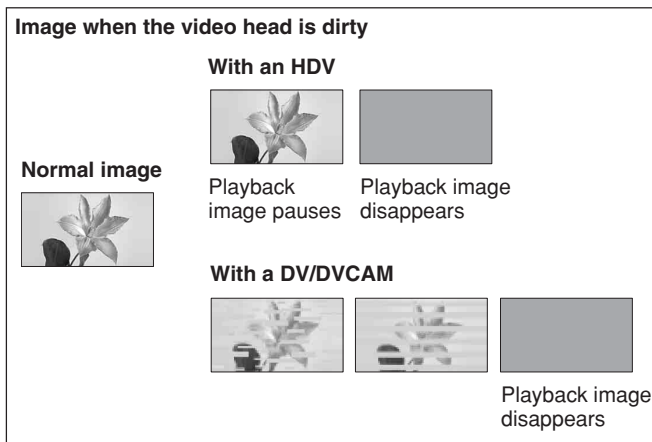

### To use the cleaning cassette

Clean the video head by playing the cleaning cassette for ten seconds.

\* If the playback image continues to be stationary or any of the symptoms on the above remain even after cleaning with the cleaning cassette, there may be a problem with the tape. Avoid using that tape.

For details, refer to your cleaning cassette’s instruction manual.

#### Note

Using the unit as below will make the video head dirty.

- Subjecting the unit to temperature change or high humidity.

→ Condensation occurs. See page 66.

- Using a damaged tape.
- Using the unit for a long time.
- Using the unit where there is a lot of dirt, dust or sand.
- Leaving a tape in the unit for a long time.

Cleaning cassettes are replaceable. After using the supplied cleaning cassette for the specified number of times, buy a cleaning cassette for replacement.

After prolonged use, the video heads may become worn out. If optimum picture quality is not restored even after you have cleaned the video heads with the cleaning cassette, the video heads may have worn out. In that case, you have to replace the video heads with new ones. Please consult your Sony dealer.

### Notes on the Video Cassettes

Note that using a tape such as those below can damage the unit.

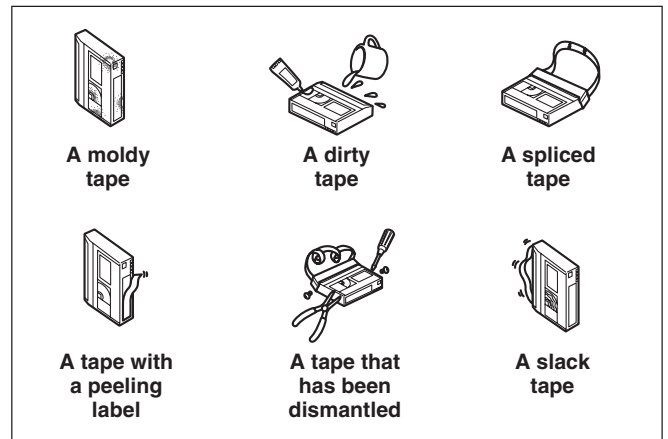

### Using cassettes

- When using a cassette for the first time we recommend that you run the tape for about five seconds before recording.
- When using a cassette that has been stored for a long time we recommend that you fast-forward and rewind it for some time. This will correct any winding irregularity in the cassette.
- Do not repeatedly insert and remove a cassette without running it. The tape may become slacked or damaged.

(Continued)

## Notes on Use

### Cleaning the terminal

If the gold-plated terminals of a cassette become dirty, or dirt accumulates on the terminals, the correct remaining tape time may not be displayed.

Clean the terminal with a swab once every ten times you eject a cassette.

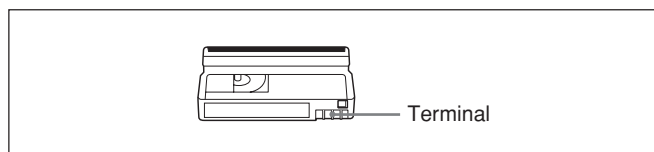

### When affixing a label to the cassette



Be sure to affix a label only on the correct location so as not to cause malfunction of the unit.

### Storing cassettes

- After using the tape rewind it, put it in its case and store vertically. (To prevent picture and sound distortion.)
- Do not store tapes in the following places:
  - Where the temperature gets high (in strong sunshine, inside a car or near a heater)
  - Where there is high humidity
  - In a strong magnetic field (near a TV or speakers)

## About Moisture Condensation

If the unit or cassette is brought directly from a cold to a warm location, moisture may condense inside or outside the unit or tape. If you use the tape or video heads in this condition, the tape may adhere to the head drum, and the video heads or the tape may be damaged, or a malfunction may occur.

When condensation occurs, the alarm messages “  Moisture condensation. Eject the cassette” or “ Moisture condensation. Turn off for 1H.” will appear.



Moisture condensation is likely to occur under the following conditions:

- The unit or cassette is brought from the cold outdoors to a warm indoor location.
- The unit or cassette is brought from the air-conditioned indoors to the hot outdoors.
- The unit is used in a place subject to cold currents from an air conditioner.

When bringing the unit or cassette from a cold place to a warm place or vice versa, put it in a plastic bag and seal the bag tightly. After bringing it into the new place, leave the bag on for more than one hour, and remove the bag when the air temperature inside it has reached the temperature surrounding it.

### If moisture condensation occurred

If moisture condensation occurs, remove the cassette immediately. While the alarm indicator is displayed, you cannot operate the unit except to press EJECT button.

Turn off the power and leave Cassette Lid open until the condensation disappears (approximately 1 hour). If the alarm message does not appear when you turn on the unit, and if  or  does not blink when you insert a cassette and press the video operation button, you can use the unit again.

If there is negligible condensation in the unit, this condensation may not be detected. In that case, the cassette may not be ejected for approximately 10 seconds. This is not a malfunction. Do not close Cassette Lid until the cassette is ejected.

## Digital Hours Meter

The digital hours meter keeps cumulative counts of the total operation time, the head drum rotation time, the tape running time and the number of unthreading operations. These counts can be displayed on the menu. Use them as guidelines for scheduling maintenance.

In general, consult your Sony dealer about necessary periodic maintenance checks.

The digital hours meter has the following four display modes and you can check them in [HOURS METER] of [OTHERS] menu (*page 54*).

### • OPERATION mode

The cumulative total hours of operating time is displayed in 10-hour increments.

### • DRUM RUN mode

The cumulative total hours of drum rotation with tape threaded is displayed in 10-hour increments.

## Notes on Use

### •TAPE RUN mode

The cumulative total hours of tape running time is displayed in 10-hour increments.

### •THREADING mode

The cumulative number of tape unthreading operations is displayed in 10-operation increments.

## About the Built-in Rechargeable Battery

The unit is provided with a rechargeable battery that retains the date/time and various settings regardless of power-on and power-off. The rechargeable battery is charged as long as the unit is operated. If the period of operating the unit is short, the battery discharges gradually and if it is not used at all for approximately 3 months, the battery will discharge completely. If that case, charge the battery and then start using the unit. If you do not need to record the date and time when the rechargeable battery is not fully charged, you can use the unit in this state.

### Charging the rechargeable battery

Connect the unit to an AC output using the AC adaptor and power cord. (The unit does not need to be turned on.)

## Using your Videocassette Recorder abroad

You can use your Videocassette Recorder in any country/region using the AC adaptor.  
Supplied within 100 V to 240 V AC, 50/60 Hz.

Use a commercially available AC plug adaptor [a], if necessary, depending on the design of the wall outlet [b].

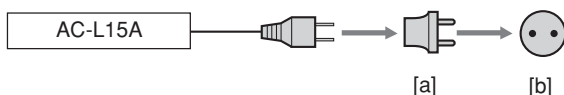

## Notes on the License

ANY USE OF THIS PRODUCT OTHER THAN CONSUMER PERSONAL USE IN ANY MANNER THAT COMPLIES WITH THE MPEG-2 STANDARD FOR ENCODING VIDEO INFORMATION FOR PACKAGED MEDIA IS EXPRESSLY PROHIBITED WITHOUT A LICENSE UNDER APPLICABLE PATENTS IN THE MPEG-2 PATENT PORTFOLIO, WHICH LICENSE IS AVAILABLE FROM MPEG LA, L.L.C., 250 STEELE STREET, SUITE 300, DENVER, COLORADO 80206.

# Appendix

## Compatibility of HDV, DVCAM, and DV Formats

HDV format is an HD VCR format based on DV format of the globally widespread general consumer digital VCR system. This format has the newly defined data recording specifications for HD signals compressed by MPEG2. It applies the same cassette, tape speed, and track pitch as DV format. The differences, compatibility, and restrictions in editing of HDV1080i, DVCAM, and DV formats are explained below.

### Main differences between HDV1080i, DVCAM, and DV Formats

(The unit and other equipment for professional use may be functionally extended. For details, see the notes below the table.)

Specification	HDV1080i	DVCAM	DV (SP)
Track pitch	10 $\mu\text{m}$	15 $\mu\text{m}$	10 $\mu\text{m}$
Audio sampling frequency	16 bit: 48 kHz	12 bit: 32 kHz 16 bit: 48 kHz	12 bit: 32 kHz 16 bit: 32 kHz, 44.1 kHz, 48 kHz <sup>2)</sup>
Audio recording mode <sup>1)</sup>	Lock mode	Lock mode	Unlock mode <sup>3)</sup>
Time code	Drop frame mode (60i only) <sup>4)</sup> No user bits <sup>5)</sup>	NTSC: SMPTE time code (DF/NDF, including user bits) PAL: EBU time code (including user bits) <sup>5)</sup>	Drop frame mode (NTSC only) <sup>4)</sup> No user bits <sup>5)</sup>

- 1) There are two modes for audio signal recording: Lock mode and Unlock mode. In Lock mode, the sampling frequencies of audio and video are synchronized. In Unlock mode, adopted by the consumer DV format, the two sampling frequencies are independent. Lock mode maintains high compatibility with higher formats and offers better digital processing and smooth transition than Unlock mode when you edit audio.
- 2) The unit cannot record in DV format with 16 bit: 32 kHz or 44.1 kHz.
- 3) The unit has been functionally extended with a function for switching between Lock mode and Unlock mode.
- 4) The unit has been functionally extended with a function to enable DF/NDF setting for 60i with HDV or DV (SP) format.
- 5) The unit does not have user bit settings. (There are some devices which you can adjust the user bit settings.)

## Playback compatibility

The compatibility between playback tape format and player is summarized in the table below.

Playback tape format \ Player	DV format model	DVCAM format model	HDV1080i format model (the unit)
DV	Playback is possible. (Some equipment cannot play a tape recorded in LP mode.)	Only playback of a tape recorded in SP mode is possible. Some equipment can play a tape recorded in LP mode.	Only playback of a tape recorded in SP mode is possible. Some equipment can play a tape recorded in LP mode. (The unit can play back a DV-formatted tape in SP mode only.)
DVCAM	Playback may be possible on some models.	Playback is possible.	Playback is possible.
HDV	No playback is possible.	No playback is possible.	Playback is possible *

\* The unit can play back for HDV720/30p format, but you cannot output the video signals from **i** HDV/DV jack. The unit cannot play back other than HDV1080/60i, HDV1080/50i, such as HDV1080/30F, HDV1080/25F, HDV1080/24F, HDV720/25p, and HDV720/24p format. The unit cannot input/output, record, or play back extended HDV format signals with 4-channel audio mode.

## Cassette compatibility

A tape with DV or miniDV mark can be used for HDV. The recording bit rate and recording track pitch on a tape of the HDV1080i system used for the unit are about 25 Mbps and 10  $\mu$ m, respectively. The specifications are the same as that of home use DV (SP) tapes. The recording time on an HDV tape is also the same as that of DV (SP). The track pitch of DVCAM is 15  $\mu$ m, which is 1.5 times of HDV/DV (SP). Therefore, the recording time using DVCAM recording on a same tape will be two-thirds of the time available when HDV/DV (SP) recording is used.



# Compatibility of HDV, DVCAM, and DV Formats

## Dubbing with S VIDEO or VIDEO jacks

When you use the unit as a recorder to perform dubbing between the unit and another equipment connected, the format to be used for recording is set in accordance with [RECORDING MODE] setting of [IN/OUT REC] menu.

For details, see the following table.

Playback and editing of a tape may be restricted for some dubbing methods. Read Chapter 3 “Dubbing/Editing” before dubbing a tape.

Some editing software can correctly edit even a tape created in [LOCK MODE]. In that case, select [LOCK MODE] if required.

## Recording tapes used when the unit serves as a recorder

Input signal format	Menu item		Recording tape format (AUDIO MODE)
	[RECORDING MODE]	AUDIO LOCK	
NTSC or PAL	DVCAM	—	DVCAM (LOCK MODE)
	DV SP	LOCK MODE	DV (LOCK MODE)
		UNLOCK MODE	DV (UNLOCK MODE)

— : Setting independent



## Dubbing with i HDV/DV jack

When you perform dubbing between the unit and digital video equipment connected with the i.LINK cable using the unit as a player, i HDV/DV jack output format is determined in accordance with the playback tape format and menu setting of the unit.

If you use the unit as a recorder, the format of a tape used for recording is determined in accordance with i HDV/DV jack input format and menu setting of the unit. For details, check the table on page 72.

Playback and editing using this tape may be limited for some dubbing methods. Before dubbing, read Chapter 3 “Dubbing/Editing”.

### i.LINK output when the unit is used as a player

Playback tape format	Menu item		i.LINK output format (AUDIO MODE)
	HDV/DV SEL	i.LINK SET HDV→DV CONV	
HDV	AUTO	OFF	HDV (LOCK MODE)
		DVCAM	DVCAM (LOCK MODE)
		DV (SP)	DV (UNLOCK MODE)
	HDV	OFF	HDV (LOCK MODE)
		DVCAM	DVCAM (LOCK MODE)
		DV (SP)	DV (UNLOCK MODE)
DV	—	No output	
DVCAM	AUTO	—	DVCAM (Complies with formats recorded in tapes)
	HDV	—	No output
	DV	—	DVCAM (Complies with formats recorded in tapes)
DV	AUTO	—	DV (Complies with formats recorded in tapes)
	HDV	—	No output
	DV	—	DV (Complies with formats recorded in tapes)

#### Notes

- When you play back a tape employed with a copy-protection signal on the unit, recording is prevented to record images from the unit to other equipment.
- You cannot up convert DVCAM(DV) format to HDV format on the unit.
- During playback in HDV, if [DV SP] is selected from [HDV→DV CONV] in [i.LINK SET], AUDIO MODE is fixed to UNLOCK MODE.
- When you play back a tape in DVCAM or DV format, the unit cannot convert between DVCAM and DV format, or switch between LOCK MODE and UNLOCK MODE.

# Compatibility of HDV, DVCAM, and DV Formats

## Recording tape when the unit is used as a recorder

i.LINK input format	Menu item		Recording tape format (AUDIO MODE) <sup>3)</sup>
	HDV/DV SEL	 REC MODE <sup>1)</sup>	
HDV	AUTO	—	HDV (LOCK MODE)
	HDV	—	HDV (LOCK MODE)
	DV	—	No recording
DVCAM	AUTO	DVCAM	DVCAM (Complies with formats recorded in tapes)
		DV SP	DV (Complies with formats recorded in tapes)
	HDV	—	No recording
	DV	DVCAM	DVCAM (Complies with formats recorded in tapes)
		DV SP	DV (Complies with formats recorded in tapes)
	DV	AUTO	DVCAM
DV SP			DV (Complies with formats recorded in tapes)
HDV		—	No recording
DV		DVCAM	DVCAM <sup>2)</sup> (Complies with formats recorded in tapes)
		DV SP	DV (Complies with formats recorded in tapes)

- 1) When the unit is used as a recorder, the recording format is determined by [ REC MODE] setting in [IN/OUT REC] menu if the input signal format is DVCAM or DV.
- 2) If you duplicate a tape when the unit is set to DVCAM as a recorder, the time code format of the duplicated tape becomes somewhat different from the time code format specified as DVCAM (note, however, that this does not affect editing accuracy in special cases).
- 3) The unit cannot switch between LOCK MODE and UNLOCK MODE. AUDIO MODE complies with input signals.

### Notes

- On the unit, HDV signals input from i.LINK cannot be down converted to DVCAM(DV) for recording.
- If you use the tapes described in 2) above for editing, you may encounter function limitations regardless of the player and recorder formats.
- Some DV video equipment may playback a DVCAM-formatted tape. Even if the tape is played back, the contents cannot be guaranteed. Therefore, if you use a proper DVCAM-formatted tape for playback, the unit may dub and create a DVCAM-formatted tape, the time code will be partially different from the time code format specified as DVCAM.
- You cannot use the unit to record video and audio delivering copyright signals. If you try to record such a video or audio, the message “Cannot record due to copyright protection.” outputs from the analog video out jack. Pictures output from COMPONENT OUT jacks are switched to either 480i or 576i automatically, regardless of the menu you have set on the unit.
- When the video signals input from  HDV/DV jack in HDV format are recorded, the user bit value is copied to the work tape. (The unit is not equipped with user bit settings and a user bit’s display function.)

## Limitations on editing

During editing, you will encounter limitations according to the format differences on a tape dubbed or edited using  HDV/DV jack.

For details, refer to “Editing (Connecting with a Computer)” of Chapter 3, “Dubbing/Editing.”



# About i.LINK

**i** HDV/DV jack provided on the unit is an i.LINK-compliant jack. This section describes the i.LINK standard and its features.

## What is i.LINK?

i.LINK is a digital serial interface for sending and receiving digital video, digital audio, and other data between the unit and other equipment equipped with an i.LINK terminal. You can also control other equipment using i.LINK.

i.LINK-compatible equipment can be connected using an i.LINK cable. Possible applications are operations and data exchange with various digital AV equipment. When two or more i.LINK-compatible equipment are connected to the unit, operations and data exchange are possible with equipment directly connected to the unit and also with equipment connected to the unit via other equipment.

Note, however, that the method of operation may vary depending on the characteristics and specifications of the equipment to be connected. Also, there are cases where operations and data exchange may not be possible even if the connection is made.

### Notes

- Normally, only one equipment can be connected to the unit using the i.LINK cable. When you connect the unit to HDV/DVCAM (DV)-compliant equipment that allows multiple connections, refer to the operating instructions of the equipment to be connected.
- i.LINK is an easy-to-remember term for the IEEE 1394 proposed by Sony, and is a trademark approved by many corporations in Japan and overseas.
- IEEE 1394 is an international standard standardized by the Institute of Electrical and Electronics Engineers.

## About the i.LINK baud rate

The maximum baud rate of i.LINK varies depending on the equipment. There are three types.

S100 (Approximately 100 Mbps\*)

S200 (Approximately 200 Mbps)

S400 (Approximately 400 Mbps)

The baud rate is listed under “Specifications” in the operating instructions of individual equipment. It may be indicated near the i.LINK interface on some equipment.

The baud rate may vary from the indicated value when the unit is connected to equipment with a different maximum baud rate.

\*What is Mbps?

Mbps stands for “megabits per second,” or the volume of data that can be sent or received in 1 second. For example, a baud rate of 100 Mbps means that 100 megabits of data can be sent in 1 second.

## To use i.LINK functions of the unit

For details on how to perform dubbing when the unit is connected to other video equipment that has an i.LINK jack, *see page 33, 37*.

The unit can also be connected to other i.LINK-compatible equipment made by Sony (i.e. a VAIO series computer) as well as video equipment.

The unit may not operate with some i.LINK video equipment such as digital televisions, DVD recorders/players, and MICROMV recorders/players even if they are equipped with i.LINK jack. Before connecting to another equipment, confirm whether this equipment is HDV/DVCAM (DV) compatible.

For details about precautions on connections and whether or not software applications compatible with the unit are available, refer to the operating instructions of the equipment to be connected.

### Notes

- When you connect with the i.LINK cable to a computer and the unit, check the direction of the jack. If you forcibly insert the jack, the terminal may be damaged or cause the unit to malfunction. Align ▲ mark of the i.LINK cable with ▼ mark on the unit and insert the i.LINK cable.
- Be sure to connect the i.LINK cable to a computer first and then connect it to the unit. If you connect the i.LINK cable to the unit first, it may cause the unit to malfunction because of static electricity.
- When you connect the unit to equipment equipped with a 6-pin type i.LINK jack, connect the cable to the 6-pin type i.LINK jack first.
- When you connect the unit to equipment equipped with an i.LINK jack using the i.LINK cable, power off the equipment and remove the power cord from the AC outlet before connecting (or disconnecting) the i.LINK cable. If the i.LINK cable is connected (or disconnected) while the equipment power cord is connected to the AC outlet, a high-voltage current (8 to 40 V) output from i.LINK jack of the equipment flows into the unit and damage it.



## About required i.LINK cable

Use a Sony i.LINK cable.

i.LINK and **i** are trademarks of Sony Corporation.

# Specifications

## System

Video/Audio recording/playing Head System	Rotating dual-head helical scan
Audio recording format (HDV)	MPEG-1 Audio Layer2 16-bit 48 kHz (stereo) Transfer rate 384 kbps
Audio recording format (DVCAM (DV))	12-bit Fs32K (Channel 1/2, Channel 3/4) 16-bit Fs48K (Channel 1/2)
Video signal	1080/60i, NTSC color, EIA standard system 1080/50i, PAL color, CCIR standard system
Usable cassettes	Standard DVCAM cassettes with  mark Mini DVCAM cassettes with  mark
Tape speed (HDV)	Approx. 18.812 mm/s
Tape speed (DVCAM)	Approx. 28.218 mm/s
Tape speed (DV)	Approx. 18.812 mm/s
Recording/playback time (HDV)	Approx. 276 min (using PHDV-276DM) Approx. 63 min (using PHDVM-63DM)
Recording/playback time (DVCAM)	Approx. 184 min (using PHDV-276DM) Approx. 41 min (using PHDVM-63DM)
Recording/playback time (DV SP)	Approx. 276 min (using PHDV-276DM) Approx. 63 min (using PHDVM-63DM)

## AUDIO jacks

IN	Pin jack: -10 dBu Impedance: Minimum 10 k $\Omega$ (kilo ohms), unbalanced Maximum input level: +16 dBu (approx. 5 Vrms) 60i system +14 dBu (approx. 4 Vrms) 50i system
OUT	Pin jack Impedance: Maximum 1 k $\Omega$ (kilo ohms) Output level: 47 k $\Omega$ (kilo ohms) loading, unbalanced -10 dBu (= full bit -20 dB) 60i system -10 dBu (= full bit -18 dB) 50i system

## VIDEO jacks

IN/OUT	Pin jack, unbalanced 1.0 Vp-p (75 $\Omega$ (ohms), sync negative) Sync signal: 0.286 Vp-p (60i/NTSC) 0.3 Vp-p (50i/PAL) Burst signal: 0.286 Vp-p (60i/NTSC) 0.3 Vp-p (50i/PAL)
--------	--

## S VIDEO jacks

IN/OUT	Mini DIN 4-pin, unbalanced Luminance signal: 1.0 Vp-p (75 $\Omega$ (ohms), sync negative) Sync signal: 0.286 Vp-p (60i/NTSC) 0.3 Vp-p (50i/PAL) Chrominance signal: 0.286 Vp-p (60i/NTSC) (burst, 75 $\Omega$ (ohms)) 0.3 Vp-p (50i/PAL) (burst, 75 $\Omega$ (ohms))
--------	---



## COMPONENT OUT jacks

OUT Pin jack

Output at 480i NTSC

With [BETACAM] selected in [IN/OUT REC] menu

Y: 1.0 Vp-p  
(with 0.286 Vp-p sync negative, output impedance 75 Ω (ohms), unbalanced)

Pb/Cb/B-Y, Pr/Cr/R-Y: 0.7 Vp-p  
(output impedance 75 Ω (ohms), unbalanced)  
(75% color bars with 7.5 IRE setup)

With [SMPTE] selected in [IN/OUT REC] menu

Y: 1.0 Vp-p  
(with 0.3 Vp-p sync negative, output impedance 75 Ω (ohms), unbalanced)

Pb/Cb/B-Y, Pr/Cr/R-Y: 0.7 Vp-p  
(output impedance 75 Ω (ohms), unbalanced)  
(100% color bars with no setup)

Output with other settings

Y: 1.0 Vp-p  
(output impedance 75 Ω (ohms), unbalanced)

Pb/Cb/B-Y, Pr/Cr/R-Y: 0.7 Vp-p  
(output impedance 75 Ω (ohms), unbalanced)  
(100% color bars with no setup)

480i/480p:

Y: with 0.3 Vp-p sync negative

1080i:

Y/Pb/Pr: with 0.6 Vp-p 3-level sync

## i HDV/DV jack

i.LINK (IEEE1394,  
4-pin connector S100)

## Remote control

LANC Stereo mini-minijack (ø 2.5)

CONTROL S IN Stereo minijack (ø 3.5)

## General

Peak inrush current

Hot switching inrush current, measured in accordance with European standard EN55103-1 : 5.0 A (230 V)

Power requirements

8.4 V (DC IN jack)

Power consumption

8 W (during playback)

Operating temperature

5 °C to 40 °C (41 °F to 104 °F)

Storage temperature

-20 °C to 60 °C  
(-4 °F to 140 °F)

Dimensions

Approx. 180 × 72.8 × 270.1 mm  
(7 1/8 × 2 7/8 × 10 3/4 inches)  
(w/h/d, including projecting parts and controls)

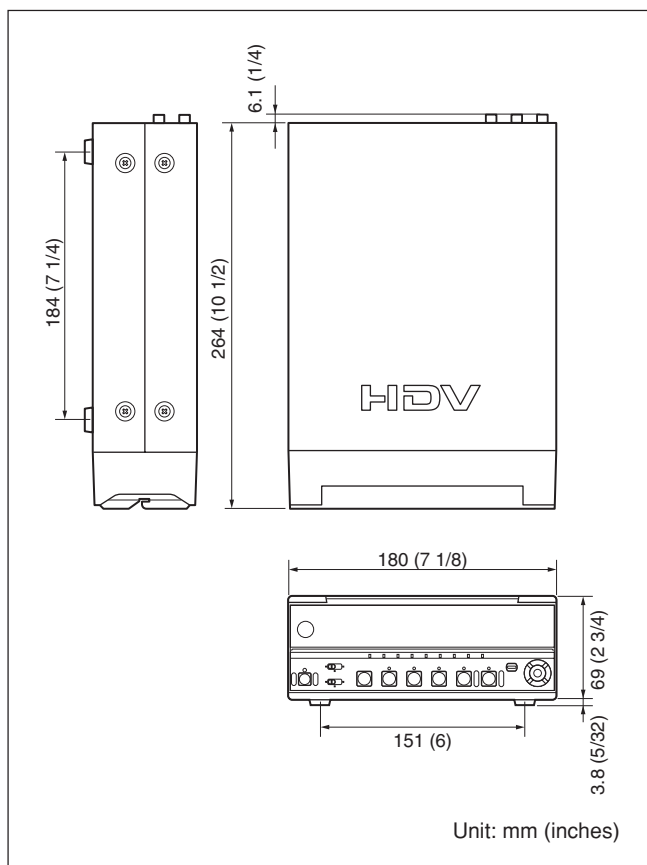

Mass

Approx. 2.3 kg (5 lb. 1 1/8 oz.)

(Continued)

# Specifications

---

## Supplied accessories

- Remote Commander (1)
- AC adaptor (1)
- Power cord (1)
- Rack (1)
- Size AA batteries (2)
- Cleaning cassette (1)
- Operating instructions (1)

## AC adaptor

### Power requirements

100 – 240 V AC, 50/60 Hz

### Current consumption

0.35 – 0.18 A

### Power consumption

18 W

### Output voltage

DC OUT: 8.4 V \*

### Operating temperature

0 °C to 40 °C (32 °F to 104 °F)

### Storage temperature

-20 °C to 60 °C (-4 °F to 140 °F)

\* See the label on the AC adaptor for other specifications.

Design and specifications are subject to change without notice.



## A

- Alarm message ..... 63
- Audio mode ..... 18

## C

- Camera data ..... 28
- Cassette ..... 20
- Cassette memory ..... 20
- Cleaning cassette ..... 65
- Clock ..... 54

## D

- Data code ..... 28
- Data display screen ..... 18
- Date search ..... 30
- Drop Frame ..... 68
- DV format ..... 68
- DV cassette ..... 20
- DVCAM format ..... 68
- DVCAM cassette ..... 20

## E

- EE mode ..... 10

## F

- FS32k ..... 35
- FS48k ..... 35

## H

- HDV/DV jack ..... 25, 33, 37, 41
- HDV format ..... 68
- HDV cassette ..... 20

## I

- i.LINK ..... 73
- Index ..... 36
- Index search ..... 30

## L

- LANC jack ..... 15
- Lock mode ..... 68

## M

- Menu ..... 44
- Menu screen ..... 18
- Mini DV cassette ..... 20
- Mini DVCAM cassette ..... 20
- Moisture condensation ..... 66

## N

- Non Drop Frame ..... 68

## P

- Playback
  - at various speeds ..... 29
  - frame by frame ..... 29

## R

- Recording ..... 32
- Remaining tape time ..... 18
- Remote Commander ..... 16

## S

- Search ..... 30
- Self-diagnosis ..... 62

## T

- Time code ..... 18
- Troubleshooting ..... 56

## U

- Unlock mode ..... 68
- Usable cassette ..... 20



# Submenu Index

## Numerics

480i LEVEL .....	48
60i/50i SEL .....	55

## A

AC ON MODE .....	54
AUDIO AGC .....	50
AUDIO LOCK .....	51
AUDIO MIX .....	50
AUDIO MODE .....	50
AUDIO REC LV .....	50
AUTO INDEX .....	51
AUTO REPEAT .....	51

## B

BARS TYPE .....	48
-----------------	----

## C

CLOCK SET .....	54
COLOR BAR .....	48
COMMANDER .....	53

## D

DATA CODE .....	49
DATE DISPLAY .....	49
DV BARS .....	48

## E

EE/PB SEL .....	48
-----------------	----

## F

FF/REW SPEED .....	51
FROM REC P .....	52
FROM STILL .....	52

## H

HDV/DV IN TC .....	52
HDV/DV SEL .....	46
HOURS METER .....	54

## I

INITIALIZE .....	55
i.LINK SET .....	47

## J

JOG AUDIO .....	51
-----------------	----

## L

LANGUAGE .....	53
LETTER SIZE .....	49

## P

PB CNR .....	54
PB YNR .....	54

## R

REC MODE .....	46
REMAINING .....	49

## S

STILL PICT .....	51
STILL TIME .....	52

## T

TC FORMAT .....	53
TC RESET .....	53
TIME DISPLAY .....	49

## V

VIDEO OUT .....	47
-----------------	----





<http://www.sony.net/>



Printed on 70% or more recycled paper using  
VOC (Volatile Organic Compound)-free  
vegetable oil based ink.

Printed in Japan

